

1845C SKID STEER

Service Manual 8-42913

Table of Contents

Description	Section No.	Publication Form No.
General		
	Tab 1	
Loctite Product Chart		8-98900
Safety Rules, Service Manual Introduction and Torque Specifications	1001	8-42910
Fluids and Lubricants	1002	8-17742
Engines		
	Tab 2	
Engine and Radiator Removal and Installation	2000	8-42910
Engine Accessories (Air Cleaner, Ether Injection System and Mufflers)	2001	8-42910
Detailed Engine Specifications	2402	8-24163
Cylinder Head and Valve Train	2415	8-24173
Cylinder Block, Crankshaft, Pistons, Rods, Camshaft, Main Bearings, Oil Seals and Flywheel	2425	8-24183
Lubrication System	2445	8-24193
Cooling System	2455	8-24203
Fuel System		
	Tab 3	
Fuel System and Filters	3410	8-24212
Fuel Injectors	3413	8-24233
CAV Injection Pump (4-390)1	3414	7-37131
Electrical		
	Tab 4	
Electrical "How it Works"	4000	7-14060
Removal and Installation of Starter and Alternator	4001	8-42910
Electrical Specifications and Troubleshooting and Schematics	4002	8-17753
Battery	4005	8-44360
Starter and Starter Solenoid	4006	8-42910
65 Ampere Alternator A187873	4007	8-15670
65 Ampere Alternator A186125	4019	8-11381
Power Train		
	Tab 6	
Hydrostatic How It Works and Troubleshooting	6000	7-14070
Removal and Installation of Piston Pumps, Motor, Planetary and Drive Coupling	6001	8-44170
Hydrostatic Drive System Troubleshooting	6002	8-17762
Piston Pump	6004	8-44180

CASE CORPORATION
700 State Street
Racine, WI 53404 U.S.A.

CASE CANADA CORPORATION
3350 South Service Road
Burlington, ON L7N 3M6 CANADA

Bur 8-18953

Copyright © 2001 Case Corporation
Printed in U.S.A.
Issued August, 1992 (Revised February, 2001)

Reprinted

Table of Contents

Description	Section No.	Publication Form No.
Motor	6005	8-44190
Controls	6006	8-44200
Sprockets, Chains and Axle Housings	6007	8-44210
Planetaries	6009	8-42910
Drive Coupling	6010	8-42910
Wheels and Tires	6011	8-44220
Hydraulics		Tab 8
How It Works	8000	7-14080
Removal and Installation of Hydraulic Components	8001	8-42910
Hydraulic System Specifications and Troubleshooting and Schematics	8002	8-17773
Cleaning the Hydraulic System and Hydrostatic System	8003	8-42910
Pump	8004	8-42910
Loader Control Valve	8005	8-44230
Auxiliary Control Valve	8006	8-42910
D125 Backhoe Control Valve -NA Only	8007	7-44240
Cylinders	8009	8-99470
Mounted Equipment		Tab 9
Control Linkages, Pedals and Levers "How it Works"	9000	7-14090
Pedals and Levers	9001	8-17782
Loader	9001	8-44250
ROPS Canopy, Seat, Seat Belts, and Operators Compartment	9003	8-44260
Auxiliary Hydraulic Installation	9004	8-42910
Backhoe (D125 Backhoe)	9005	7-44270
Rear Pocket		
Hydraulic and Electrical Schematic Foldout	In Rear Pocket	7-11941

NOTE: Case Corporation reserves the right to make improvements in design or changes in specifications at any time without incurring any obligation to install them on units previously sold.

<https://caseihservicemanual.com/>

1001

SAFETY RULES SERVICE MANUAL INTRODUCTION AND TORQUE SPECIFICATIONS

TABLE OF CONTENTS

Safety Rules	1001-2	Illustrations and Photos	1001-4
Service Manual Introduction	1001-4	Clear and Simple English	1001-4
Right, Left, Front, and Rear	1001-4	Special Tools	1001-4
Text	1001-4	Product Identification Number (PIN) and Serial Numbers	1001-5
Table of Contents	1001-4	Torque Specifications	1001-6
Page Numbers	1001-4		

SAFETY RULES

 This symbol means **ATTENTION! BECOME ALERT! YOUR SAFETY IS INVOLVED.** The message that follows the symbol contains important information about safety. Carefully read the message. Make sure you fully understand the causes of possible injury or death. 1-1-C

IMPORTANT: To prevent injury on the job, follow the Warning, Caution, and Danger notes in this section and other sections throughout this manual. Follow the instructions carefully.

The procedures recommended and shown in this manual are good, effective service methods. However, all possible procedures and service hazards may not be covered. Therefore, if you use a tool or procedure not recommended, you must make sure that the method you select is a safe method.

Put the warning tag shown below on the key for the key switch when you are servicing or repairing this machine. One warning tag is on every new machine. You can buy additional warning tags, part number 331-4614, from Service Parts Supply.

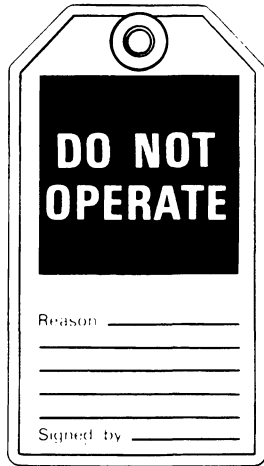

780449

 **WARNING:** Read operator's manual to familiarize yourself with control lever functions. 46-27

 **WARNING:** Operate tractor and equipment controls from the seat position only. Any other method could result in serious injury. 48-55

 **WARNING:** This is a one man machine, no riders allowed. 35-8

 **WARNING:** If you wear clothing that is too loose or do not use the correct safety equipment for your job, you can be injured. Always wear clothing that will not catch on objects. Extra safety equipment that can be required includes hard hat, safety shoes, ear protection, eye or face protection, heavy gloves and reflector clothing. 45-3-A

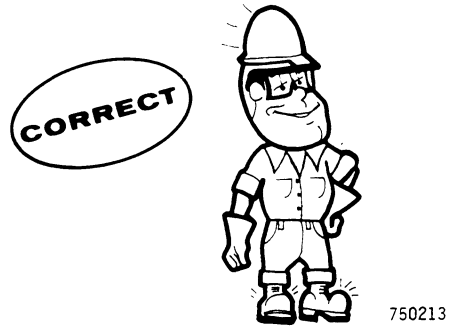

 **DANGER:** Engine exhaust fumes can cause death. If it is necessary to start the engine in a closed place, remove the exhaust fumes from the area with an exhaust pipe extension. If you do not have an exhaust pipe extension, open the doors and get outside air into the area. 48-56

 **WARNING:** Operate controls from the operator's seat only. 35-7

 **WARNING:** When working in the area of the fan belt with the engine running, avoid loose clothing if possible, and use extreme caution. 35-4

 **WARNING:** Whenever the bucket must be raised to aid in servicing, block the loader arms in place with lift cylinder support strut or a suitable safety stand. 23-7-B

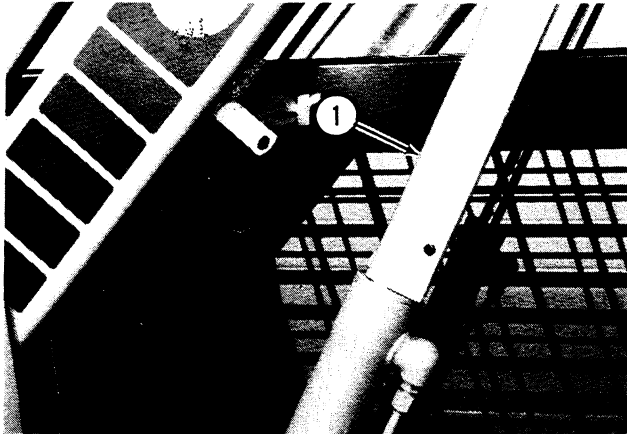



1. Lift Cylinder Support Strut 855871

 **WARNING:** When doing checks and tests on the equipment hydraulics, follow the procedures as they are written. DO NOT change the procedure. 47-44

 **WARNING:** When putting the hydraulic cylinders on this machine through the necessary cycles to check operation or to remove air from a circuit, make sure all people are out of the way. 47-45

 **WARNING:** Use insulated gloves or mittens when working with hot parts. 47-41A

 **CAUTION:** Pin sized and smaller streams of hydraulic oil under pressure can penetrate the skin and result in serious infection. If hydraulic oil under pressure does penetrate the skin, seek medical treatment immediately. Maintain all hoses and tubes in good condition. Make sure all connections are tight. Make a replacement of any tube or hose that is damaged or thought to be damaged. DO NOT use your hand to check for leaks; use a piece of cardboard or wood. 40-6-A

 **CAUTION:** When removing hardened pins such as a pivot pin, or a hardened shaft, use a soft head (brass or bronze) hammer or use a driver made from brass or bronze and a steel head hammer. 46-17

 **CAUTION:** When using a hammer to remove and install pivot pins or separate parts, using compressed air or using a grinder, wear eye protection that completely encloses the eyes (approved goggles or other approved eye protectors). 46-13

 **CAUTION:** When servicing or repairing the machine, keep the shop floor and operator's compartment and steps free of oil, water, grease, tools, etc. Use an oil absorbing material and/or shop cloths as required. Use safe practices at all times. 40-8

 **CAUTION:** Use suitable floor (service) jacks or chain hoists to raise wheels or track off the floor. Always block machine in place with suitable safety stands. 40-7-A

 **CAUTION:** Some components of this machine are very heavy. Use suitable lifting equipment or additional help as instructed in this service manual. 40-10

SERVICE MANUAL INTRODUCTION

This service manual has been prepared with the latest service information available. Troubleshooting, removal, disassembly, inspection and installation procedures, and complete specifications and tightening references can be found in most sections. Some sections have drawings but no written procedure because the job is so easily done. This service manual is one of the most important tools available to the service technician.

Right, Left, Front, and Rear

The terms right-hand and left-hand and front and rear as used in this manual indicate the right and left sides, and front and rear of the machine as seen from the operator's seat for correct operation of the machine or attachment.

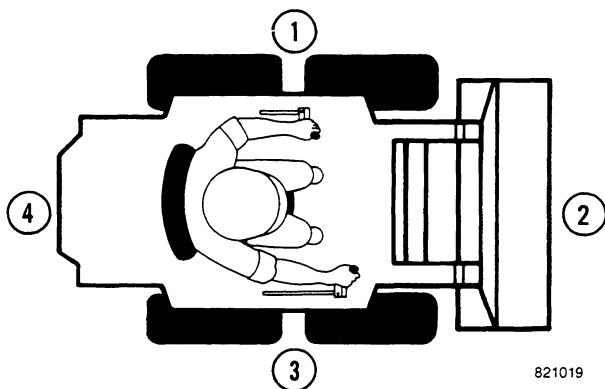

- | | |
|--------------|---------------|
| 1. Left Side | 3. Right Side |
| 2. Front | 4. Rear |

Text

If the service manual is for more than one machine or different models of components (planetary axles, gear boxes, control valves, etc.) the procedures have the steps necessary to service each model.

Table of Contents

A Table of Contents is in the front of this manual. The Table of Contents shows the main divisions and the sections that are in each division. The individual sections, where necessary, have a Table of Contents on the cover or second page of that section.

Page Numbers

All page numbers are made of two numbers separated by a dash, such as 4002-9. The number before the dash is the section number. The number following the dash is the page number in that section. Page numbers will be found at the upper right or left of each page.

Illustrations and Photos

Illustrations are put as near as possible to the text and are to be used as part of the text. Photos normally are put below the step to which they apply.

Clear and Simple English

This manual is written in C.A.S.E. (Clear and Simple English). C.A.S.E. is easier to read and understand than "regular" English because C.A.S.E. uses a small number of common words and has special rules for writing.

Special Tools

Special tools are needed to remove and install, disassemble and assemble, check, and adjust some component parts of this machine. Some special tools can be easily made locally and the necessary information to make the tool is in this service manual. Other special tools are more difficult to make locally and are available from Service Tools in the U.S. and from Jobborn Manufacturing in Canada. Use these tools according to the instructions in this service manual for your personal safety and to do the job correctly.

Order special tools from either of the following companies:

Service Tools
P.O. Box 314
Owatonna, Minnesota 55060

Jobborn Manufacturing Co.
97 Frid Street
Hamilton, Ontario L8P 4M3
Canada

PRODUCT IDENTIFICATION NUMBER (PIN) AND SERIAL NUMBERS

NOTE: *A serial number plate is also on some components such as the starter, alternator, pump, etc.*

TORQUE SPECIFICATIONS - U.S. HARDWARE

Use the torques in this chart when special torques are not given. These torques apply to fasteners with both UNC and UNF threads as received from suppliers, dry, or when lubricated with engine oil. Not applicable if special graphites, moly-disulfide greases, or other extreme pressure lubricants are used.

Grade 5 Bolts, Nuts, and Studs			
			
Size	Pound-Feet	Newton metres	Kilogram metres
1/4 in 6.4 mm	9-11	12-15	1.2-1.5
5/16 in 7.9 mm	17-21	23-28	2.4-2.9
3/8 in 9.5 mm	35-42	48-57	4.8-5.8
7/16 in 11.1 mm	54-64	73-87	7.5-8.8
1/2 in 12.7 mm	80-96	109-130	11.1-13.3
9/16 in 14.3 mm	110-132	149-179	15.2-18.2
5/8 in 15.9 mm	150-180	203-244	20.8-24.9
3/4 in 19.0 mm	270-324	366-439	37.3-44.8
7/8 in 22.2 mm	400-480	542-651	55.3-66.4
1.0 in 25.4 mm	580-696	787-944	80.2-96.2
1-1/8 in 28.6 mm	800-880	1085-1193	111-122
1-1/4 in 31.8 mm	1120-1240	1519-1681	155-171
1-3/8 in 34.9 mm	1460-1680	1980-2278	202-232
1-1/2 in 38.1 mm	1940-2200	2631-2983	268-304

Grade 8 Bolts, Nuts, and Studs			
			
Size	Pound-Feet	Newton metres	Kilogram metres
1/4 in 6.4 mm	12-15	16-20	1.7-2.1
5/16 in 7.9 mm	24-29	33-39	3.3-4.0
3/8 in 9.5 mm	45-54	61-73	6.2-7.5
7/16 in 11.1 mm	70-84	95-114	9.7-11.6
1/2 in 12.7 mm	110-132	149-179	15.2-18.2
9/16 in 14.3 mm	160-192	217-260	22.1-26.5
5/8 in 15.9 mm	220-264	298-358	30.4-36.5
3/4 in 19.0 mm	380-456	515-618	52.5-63.0
7/8 in 22.2 mm	600-720	814-976	83.0-99.5
1.0 in 25.4 mm	900-1080	1220-1465	124-149
1-1/8 in 28.6 mm	1280-1440	1736-1953	177-199
1-1/4 in 31.8 mm	1820-2000	2468-2712	252-277
1-3/8 in 34.9 mm	2380-2720	3227-3688	329-376
1-1/2 in 38.1 mm	3160-3560	4285-4827	437-492

TORQUE SPECIFICATIONS - METRIC HARDWARE

Use the following torques when special torques are not given.

These values apply to fasteners with coarse threads as received from supplier, plated or unplated, or when lubricated with engine oil. These values do not apply if graphite or moly-disulfide grease or oil is used.

Grade 8.8 Bolts, Nuts, and Studs			
			
Size	Pound-Feet	Newton metres	Kilogram metres
M4 0.15 in	2-3	3-4	0.3-0.4
M5 0.19 in	5-6	6.5-8	0.7-0.8
M6 0.23 in	8-9	10.5-12	1.1-1.2
M8 0.31 in	19-23	26-31	2.6-3.2
M10 0.39 in	38-45	52-61	5.3-6.2
M12 0.46 in	66-79	90-107	9.1-10.9
M14 0.55 in	106-127	144-172	14.7-17.6
M16 0.62 in	160-200	217-271	22.1-27.7
M20 0.78 in	320-380	434-515	44.2-52.5
M24 0.94 in	500-600	675-815	69.1-83.0
M30 1.17 in	920-1100	1250-1500	127-152
M36 1.40 in	1600-1950	2175-2600	221-270

Grade 10.9 Bolts, Nuts, and Studs			
			
Size	Pound-Feet	Newton metres	Kilogram metres
M4 0.15 in	3-4	4-5	0.4-0.5
M5 0.19 in	7-8	9.5-11	1.0-1.1
M6 0.23 in	11-13	15-17.5	1.5-1.8
M8 0.31 in	27-32	37-43	3.7-4.4
M10 0.39 in	54-64	73-87	7.5-8.8
M12 0.46 in	93-112	125-150	12.9-15.5
M14 0.55 in	149-179	200-245	20.6-24.7
M16 0.62 in	230-280	310-380	31.8-38.7
M20 0.78 in	450-540	610-730	62.2-74.7
M24 0.94 in	780-940	1050-1275	108-130
M30 1.17 in	1470-1770	2000-2400	203-245
M36 1.40 in	2580-3090	3500-4200	357-427

Grade 12.9 Bolts, Nuts, and Studs



Usually the torque values specified for grade 10.9 fasteners can be used satisfactorily on grade 12.9 fasteners.

TORQUE SPECIFICATIONS - STEEL HYDRAULIC FITTINGS

Tube OD Hose ID	Thread Size	Pound- Feet	Newton metres	Kilogram metres
37 Degree Flare Fittings				
1/4 in 6.4 mm	7/16-20	6-12	8-16	0.8-1.7
5/16 in 7.9 mm	1/2-20	8-16	11-21	1.1-2.2
3/8 in 9.5 mm	9/16-18	10-25	14-33	1.4-3.5
1/2 in 12.7 mm	3/4-16	15-42	20-56	2.1-5.8
5/8 in 15.9 mm	7/8-14	25-58	34-78	3.5-8.0
3/4 in 19.0 mm	1-1/16-12	40-80	54-108	5.5-11.1
7/8 in 22.2 mm	1-3/16-12	60-100	81-135	8.3-13.9
1.0 in 25.4 mm	1-5/16-12	75-117	102-158	10.4-16.2
1-1/4 in 31.8 mm	1-5/8-12	125-165	169-223	17.3-22.8
1-1/2 in 38.1 mm	1-7/8-12	210-250	285-338	29.0-34.6

Tube OD Hose ID	Thread Size	Pound- Feet	Newton metres	Kilogram metres
Straight Threads with O-ring				
1/4 in 6.4 mm	7/16-20	12-19	16-25	1.7-2.6
5/16 in 7.9 mm	1/2-20	16-25	22-33	2.2-3.5
3/8 in 9.5 mm	9/16-18	25-40	34-54	3.5-5.5
1/2 in 12.7 mm	3/4-16	42-67	57-90	5.8-9.3
5/8 in 15.9 mm	7/8-14	58-92	79-124	8.0-12.7
3/4 in 19.0 mm	1-1/16-12	80-128	108-174	11.1-17.8
7/8 in 22.2 mm	1-3/16-12	100-160	136-216	13.8-22.1
1.0 in 25.4 mm	1-5/16-12	117-187	159-253	16.2-25.9
1-1/4 in 31.8 mm	1-5/8-12	165-264	224-357	22.8-36.5
1-1/2 in 38.1 mm	1-7/8-12	250-400	339-542	34.6-55.3

Split Flange Mounting Bolts			
Size	Pound- Feet	Newton metres	Kilogram metres
5/16-18	15-20	20-27	2.1-2.8
3/8-16	20-25	26-33	2.8-3.5
7/16-14	35-45	47-61	4.7-6.2
1/2-13	55-65	74-88	7.6-9.0
5/8-11	140-150	190-203	19.4-20.7

Section 1002

FLUIDS AND LUBRICANTS 1845C Skid Steer

CASE CORPORATION
700 State Street
Racine, WI 53404 U.S.A.

CASE CANADA CORPORATION
450 Sherman Avenue
Hamilton, ON L8N 4C4 CANADA

Bur 8-17742

© 1998 Case Corporation
Printed in U.S.A.
December, 1998

TABLE OF CONTENTS

CAPACITIES AND LUBRICANTS	2
ENGINE LUBRICATION	3
Engine Oil Selection	3
Oil Viscosity / Temperature Usage Recommendation.....	3
MAINTENANCE SCHEDULE	4, 6
MAINTENANCE LOCATIONS	5, 7
DX100 - DX100XR BACKHOE PIVOTS.....	8 - 9
D125 BACKHOE PIVOTS	10

CAPACITIES AND LUBRICANTS

ENGINE OIL

Capacity with filter change	10.4 litres (11 U.S. quarts)
Type of oil	See Engine Oil Recommendations on Page 3
Oil Level Check Interval	Every 10 Hours of Operation or One Time Each Day
Oil Change and Filter Replacement Interval.....	Every 250 Hours of Operation

ENGINE COOLING SYSTEM

Capacity	17 litres (18 U.S. quarts)
Type of coolant	Ethylene glycol and water mixed for lowest ambient temperature at least 50/50 mix

FUEL TANK

Capacity	81.4 litres (21.5 U.S. gallons)
----------------	---------------------------------

HYDRAULIC SYSTEM

System capacity.....	39.7 litres (10.5 U.S. gallons)
Reservoir capacity with filter change	32.2 litres (8.5 U.S. gallons)
Reservoir capacity without filter change	31.2 litres (8.25 U.S. gallons)
Type of oil (Specifications)	Case No. 1 engine oil SAE 10W30 (API Service CE, CD, CC/SG) mixed with Case HTO additive

NOTE: *Machines prior to PIN JAF0067438 do not need the Case HTO additive. All machines PIN JAF0067438 and after must have the Case HTO additive mixed as instructed.*

WHEN CHANGING OIL: When you change the hydraulic oil, you must add 1.4 litres (1.5 U.S. quarts) of Case HTO additive (Case part number B17508).

WHEN ADDING OIL: When you add oil to the hydraulic reservoir between oil changes, you must use a mixture of Case HTO additive and SAE 10W-30 engine oil. Completely mix one U.S. quart of Case HTO additive to 19 litres (5 U.S. gallons) of 10W-30 engine oil (20 to 1 ratio).

DRIVE CHAIN COMPARTMENTS

Capacity (each)	4.7 litres (5 U.S. quarts)
Type of oil (Specifications)	Case No. 1 engine oil - SAE 10W30

PLANETARIES (Only Before PIN JAF0067438)

Capacity (each side)	0.5 litres (1 U.S. pint)
Type of oil (Specifications)	Case No. 1 engine oil - SAE 10W30

GREASE FITTINGS

Quantity	As required
Specifications	Case molydisulfide grease

BATTERY

Quantity	As required
Specifications	Drinking or distilled water

ENGINE LUBRICATION Engine Oil Selection

Case No. 1 Engine Oil is recommended for use in your Case Uni-Loader Engine. Case Engine Oil will lubricate your engine correctly under all operating conditions.

If Case No. 1 Multi-Viscosity or Single Viscosity Engine Oil is not available, use only oil meeting API engine oil service category CE.



ts98h007



tr98h001

See the chart below for recommended viscosity at ambient air temperature ranges.

NOTE: Do not put Performance Additives or other oil additive products in the engine crankcase. The oil change intervals given in this manual are according to tests with Case Lubricants.

Oil Viscosity / Temperature Usage Recommendation

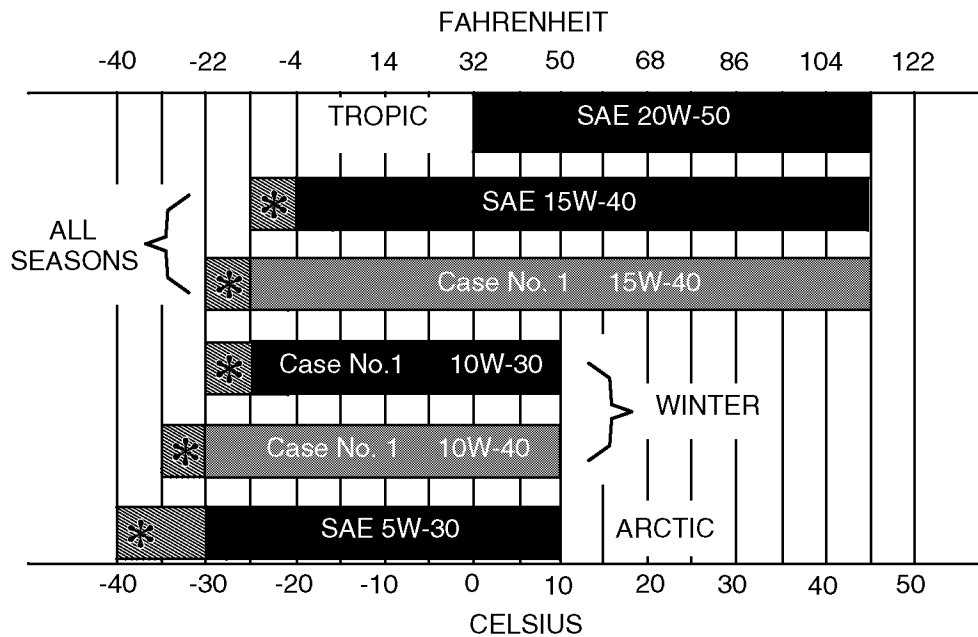

* Use of an engine oil heater, or an engine coolant heater, is required in crosshatched area.

ts98h006

MAINTENANCE SCHEDULE									
SERVICE ITEM		AS REQUIRED	EVERY 10 HOURS OF OPERATION OR DAILY	EVERY 50 HOURS OF OPERATION	EVERY 100 HOURS OF OPERATION	EVERY 250 HOURS OF OPERATION	EVERY 500 HOURS OF OPERATION	EVERY 1000 HOURS OF OPERATION	EVERY 2000 HOURS OF OPERATION
1.	Lubricate the Loader Pivot Points (16 Grease Fittings) Case Molydisulfide Grease.		●						
2.	Check the Precleaner for the Air Cleaner - if Equipped. See Operators Manual.		●						
3.	Service the Air Cleaner if the Air Cleaner Warning Lamps On. See Operators Manual.	●							
3.	Clean and Check the Air Cleaner Dust Valve. See Operators Manual.			●					
3.	Replace the Air Cleaner Elements. Use Case Filter.								●
4.	Inspect the Rops. See Operators Manual.						●		
5.	Check the Wheel Nut Torque, 115 to 125 lb ft (156 To 170 Nm). See Section 6008	●							
6.	Check the Drive Chain Tension (Each Side). See Section 9001.					●			
7.	Lubricate the Cluster Sprocket Bearings (2 Grease Fittings) Case Molydisulfide Grease.					●			
8.	Drain Water from the Fuel Filter. See Operators Manual.			●					
9.	Change Engine Oil and Replace the Engine Oil Filter. Case No. 1 Engine Oil, Use Case Filters.					●			
10.	Replace the Fuel Filter(s). See Operators Manual.						●		
11.	Clean Dirt and Debris from the Engine Area.	●							
12.	Check the Fan Belt for Wear Replace if Damaged.	●							
13.	Drain, Flush and Refill the Engine Cooling System (See Note 3). Ethylene Glycol and Water.								●
14.	Check Engine Oil Level Case No. 1 Engine Oil.		●						
15.	Check and Clean the Hydraulic Oil Cooler. See Operators Manual.		●						
<p>NOTE 1: When adding oil to the hydraulic reservoir between oil changes, use a mixture of Case HTO additive and SAE 10W30 engine oil. Completely mix one U.S. quart of Case HTO additive to 19 litres (5 U.S. gallons) of SAE 10W30 oil (20 to 1 ratio).</p>									
<p>NOTE 2: When changing the hydraulic oil in the reservoir, add 1.7 litres (1.6 U.S. gallons) of Case HTO additive (Case Part No. B17508).</p>									
<p>NOTE 3: Use Ethylene Glycol and water that is mixed 50/50. When adding to the engine, use this mixture.</p>									

MAINTENANCE LOCATIONS

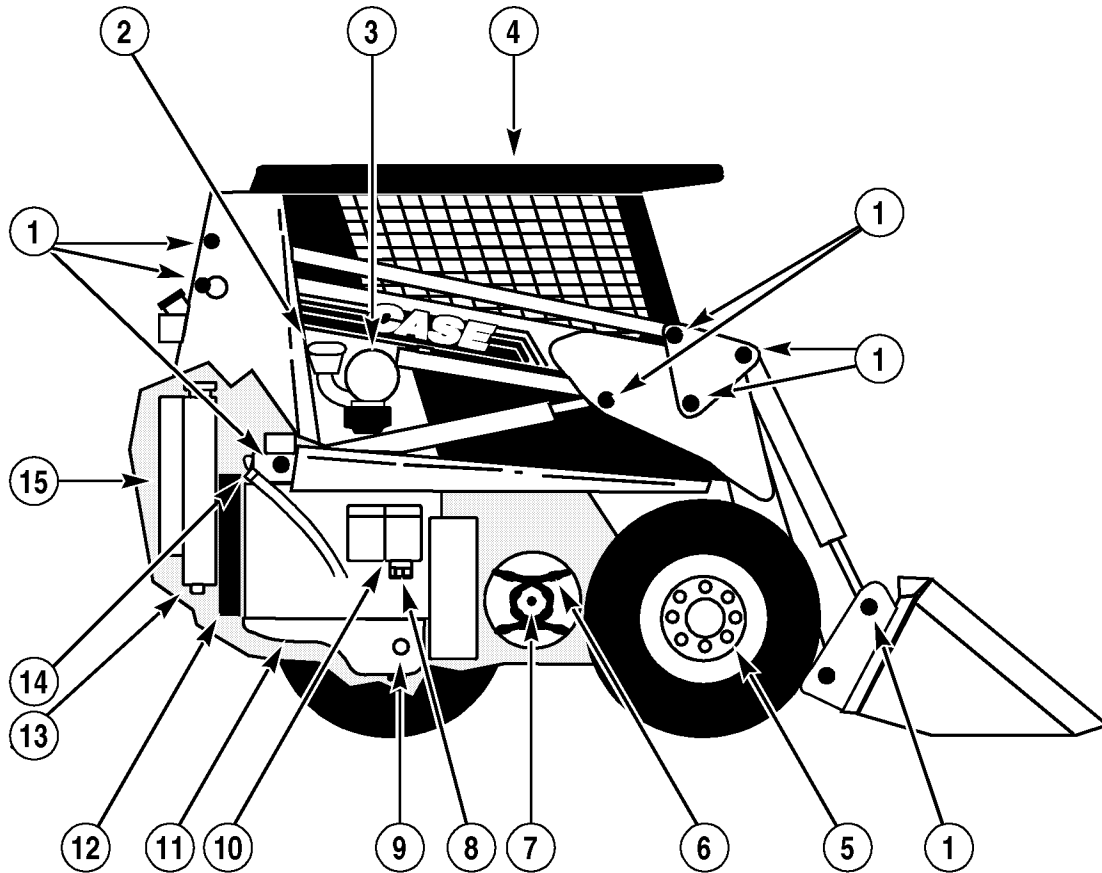

ts98h004

IF YOU OPERATE THE MACHINE IN SEVERE CONDITIONS, LUBRICATE AND SERVICE THE MACHINE MORE FREQUENTLY. IT IS RECOMMENDED THAT YOU SEE YOUR **CASE** DEALER FOR INFORMATION ON THE SYSTEMGARD LUBRICATION SYSTEM.

SEE YOUR OPERATORS MANUAL FOR MAINTENANCE OF SAFETY RELATED ITEMS AND FOR DETAILED INFORMATION OF THE SERVICE ITEMS ON THIS CHART. OPERATORS AND SERVICE MANUALS ARE AVAILABLE FOR THIS MACHINE FROM YOUR **CASE** DEALER.

MAINTENANCE SCHEDULE

SERVICE ITEM	AS REQUIRED	EVERY 10 HOURS OF OPERATION OR DAILY	EVERY 50 HOURS OF OPERATION	EVERY 100 HOURS OF OPERATION	EVERY 250 HOURS OF OPERATION	EVERY 500 HOURS OF OPERATION	EVERY 1000 HOURS OF OPERATION	EVERY 2000 HOURS OF OPERATION
16. Drain Water from the Fuel Tank. See Operators Manual.							●	
17. Change the Chain Compartment Oil (Each Side) Case No. 1 Engine Oil (SAE 10W30).						●		
18. Change Engine Oil and Replace the Engine Oil Filter. Case No. 1. Engine Oil, Use Case Filters.					●			
19. Clean the Spark Arrester Muffler. See Operators Manual.				●				
20. Check the Engine Valve Clearance. See Service Manual.							●	
21. Clean the Battery and Check the Battery Fluid Level. Add Drinking or Distilled Water.					●			
22. Change the Planetary Oil (Each Side) Only Before PIN JAF0067438. Case 135H EP Gear Lube.							●	
23. Lubricate the Coupler Wedges (2 Grease Fittings) if Equipped. Case Molydisulfide Grease.		●						
24. Lubricate the Case Coupler Latch Pivots (2 Grease Fittings. Case Molydisulfide Grease.					●			
25. Check the Tire Air Pressure and Tire Condition. See Section 6008.			●					
26. Lubricate Each Axle Bearing (4 Grease Fittings). Case Molydisulfide Grease.					●			
27. Lubricate the Loader Cross Shaft Pivot (2 Grease Fittings). Case Molydisulfide Grease.					●			
28. Lubricate the Drive Shaft Universals (2 Fittings). Case Molydisulfide Grease.						●		
29. Replace the Hydraulic Oil Filter. Use Case Filters.						●		
29. Replace the Hydraulic Filter if the Hydraulic Filter Warning Lamp Is On. Use Case Filters.	●							
30. Change the Hydraulic Oil (See Note 2). Case No.1 Engine Oil.							●	
31. Check the Hydraulic Reservoir Oil Level. (See Note 1). Case No. 1 Engine Oil.		●						
32. Check Engine Oil Level. Case No. 1 Engine Oil.		●						
33. Check the Radiator Coolant Level (See Note 3). Ethylene Glycol and Water.					●			
34. Check the Engine Coolant Reservoir Fluid Level (See Note 3). Ethylene Glycol And Water.		●						

MAINTENANCE LOCATIONS

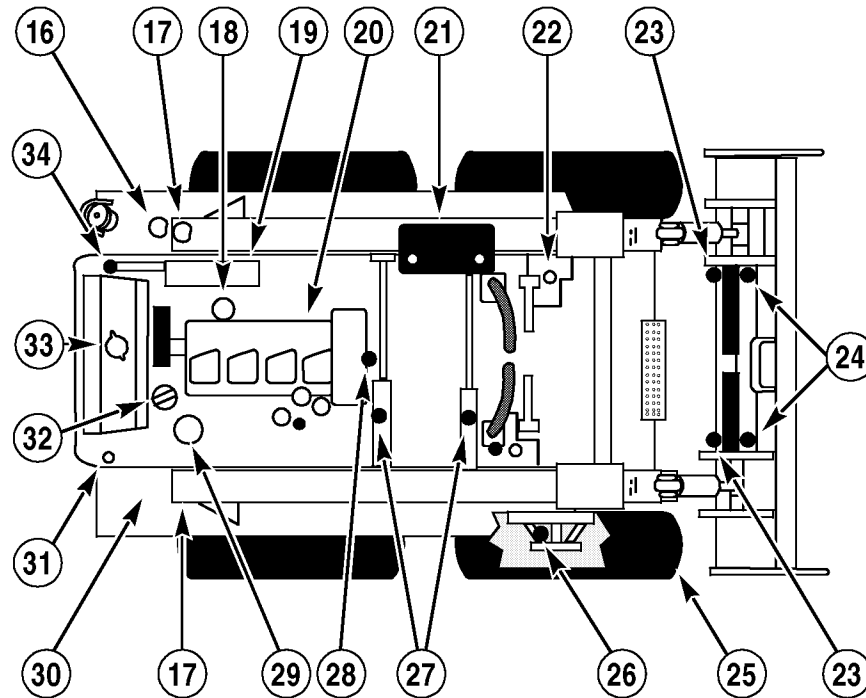

ts98h005

IF YOU OPERATE THE MACHINE IN SEVERE CONDITIONS, LUBRICATE AND SERVICE THE MACHINE MORE FREQUENTLY. IT IS RECOMMENDED THAT YOU SEE YOUR **CASE** DEALER FOR INFORMATION ON THE SYSTEMGARD LUBRICATION SYSTEM.

SEE YOUR OPERATORS MANUAL FOR MAINTENANCE OF SAFETY RELATED ITEMS AND FOR DETAILED INFORMATION OF THE SERVICE ITEMS ON THIS CHART. OPERATORS AND SERVICE MANUALS ARE AVAILABLE FOR THIS MACHINE FROM YOUR **CASE** DEALER.

D100 - D100XR BACKHOE PIVOTS (IF EQUIPPED) Use Case Molydisulfide Grease

SERVICE ITEM		AS REQUIRED	EVERY 10 HOURS OF OPERATION OR DAILY	EVERY 50 HOURS OF OPERATION	EVERY 100 HOURS OF OPERATION	EVERY 250 HOURS OF OPERATION	EVERY 500 HOURS OF OPERATION	EVERY 1000 HOURS OF OPERATION	EVERY 2000 HOURS OF OPERATION
	Lubricate the Backhoe Pivot Points (8 Fittings D100 Backhoe and 12 Fittings D100XR Backhoe). Case Molydisulfide Grease.		●						
	Lubricate the Manure Fork Grapple (2 Grease Fittings) if Equipped. Not Shown. Case Molydisulfide Grease.		●						
	Check the Control Linkages and Test Seat Bar Operation. See Section 9001.		●						
1.	Upper Swing Pivot - 1 Fitting		●						
2.	Dipper Cylinder, Closed End - 1 Fitting		●						
3.	Boom Cylinder, Closed End - 1 Fitting		●						
4.	Dipper Pivot - 1 Fitting		●						
5.	Dipper Cylinder, Rod End - 1 Fitting		●						
6.	Bucket Cylinder, Closed End - 1 Fitting		●						
7.	Bucket Cylinder, Rod End - 1 Fitting		●						
8.	Boom Cylinder, Rod End - 1 Fitting		●						
9.	Boom Pivot		●						
10.	Lower Swing Pivot - 1 Fitting		●						
11.	Stabilizer Pivot - 2 Fittings (One Each Side)		●						

D100 - D100XR BACKHOE PIVOTS (IF EQUIPPED) Use Case Molydisulfide Grease

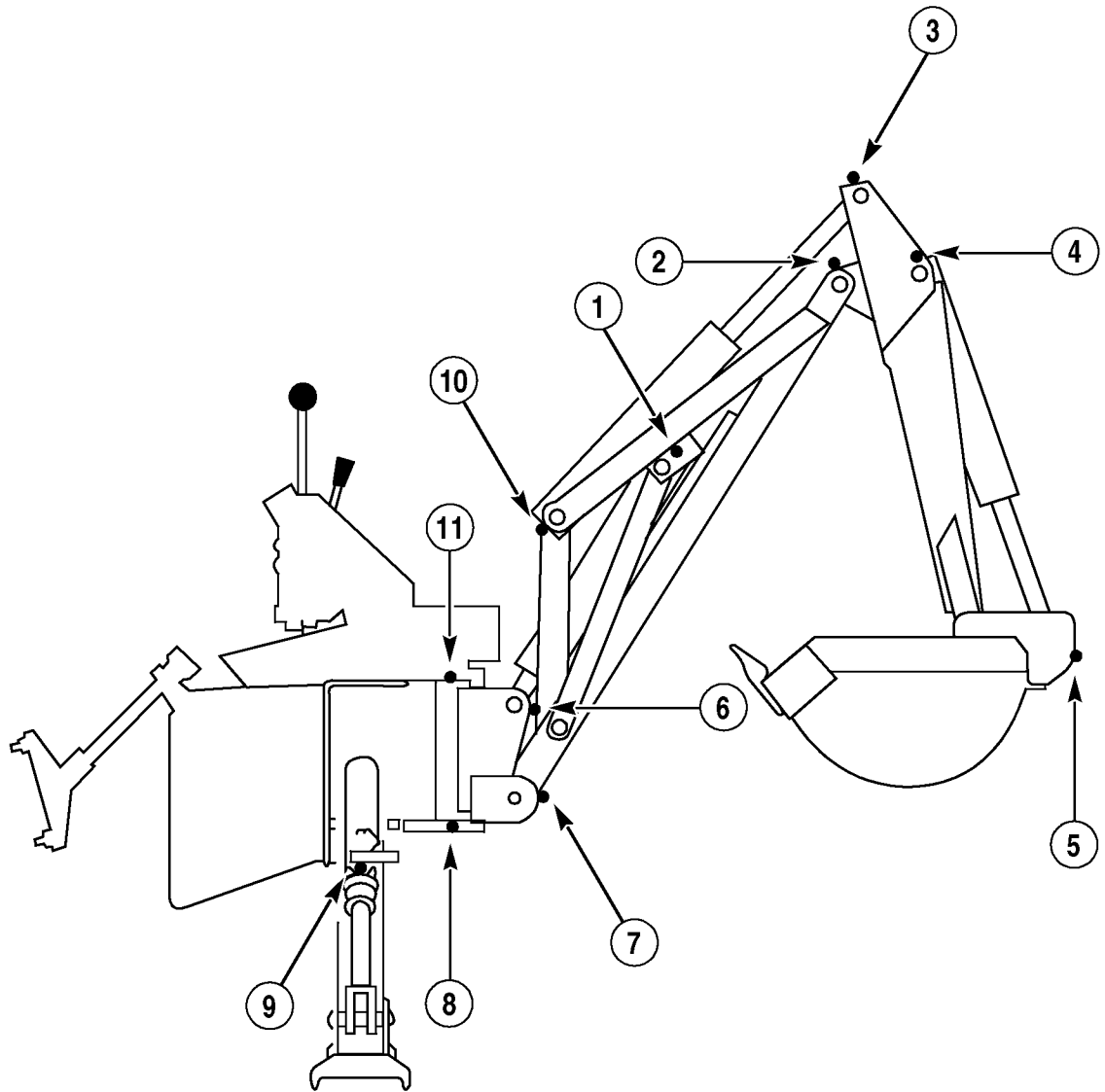

ts98h008

IF YOU OPERATE THE MACHINE IN SEVERE CONDITIONS, LUBRICATE AND SERVICE THE MACHINE MORE FREQUENTLY. IT IS RECOMMENDED THAT YOU SEE YOUR **CASE** DEALER FOR INFORMATION ON THE SYSTEMGARD LUBRICATION SYSTEM.

SEE YOUR OPERATORS MANUAL FOR MAINTENANCE OF SAFETY RELATED ITEMS AND FOR DETAILED INFORMATION OF THE SERVICE ITEMS ON THIS CHART. OPERATORS AND SERVICE MANUALS ARE AVAILABLE FOR THIS MACHINE FROM YOUR **CASE** DEALER.

D125 BACKHOE PIVOTS (IF EQUIPPED) Use Case Molydisulfide Grease

SERVICE ITEM		AS REQUIRED	EVERY 10 HOURS OF OPERATION OR DAILY	EVERY 50 HOURS OF OPERATION	EVERY 100 HOURS OF OPERATION	EVERY 250 HOURS OF OPERATION	EVERY 500 HOURS OF OPERATION	EVERY 1000 HOURS OF OPERATION	EVERY 2000 HOURS OF OPERATION
	Lubricate the Backhoe Pivot Points (22 Fittings D125 Backhoe). Case Molydisulfide Grease.		●						
	Lubricate the Manure Fork Grapple (2 Grease Fittings) if Equipped. Not Shown. Case Molydisulfide Grease.		●						
	Check the Control Linkages and Test Seat Bar Operation. See Section 9001.		●						
1.	Upper Swing Pivot - 1 Fitting		●						
2.	Boom Cylinder - 2 Fittings		●						
3.	Dipper Pivot - 1 Fitting		●						
4.	Bucket Cylinder, Closed End - 1 Fitting		●						
5.	Bucket Cylinder, Rod End - 1 Fitting		●						
6.	Bucket Pivot and Linkage - 2 Fittings		●						
7.	Dipper Cylinder - 2 Fittings		●						
8.	Boom Pivot		●						
9.	Lower Swing Pivot - 1 Fitting		●						
10.	Stabilizer Pivot - 2 Fittings (One Each Side)		●						

D125 BACKHOE PIVOTS (IF EQUIPPED) Use Case Molydisulfide Grease

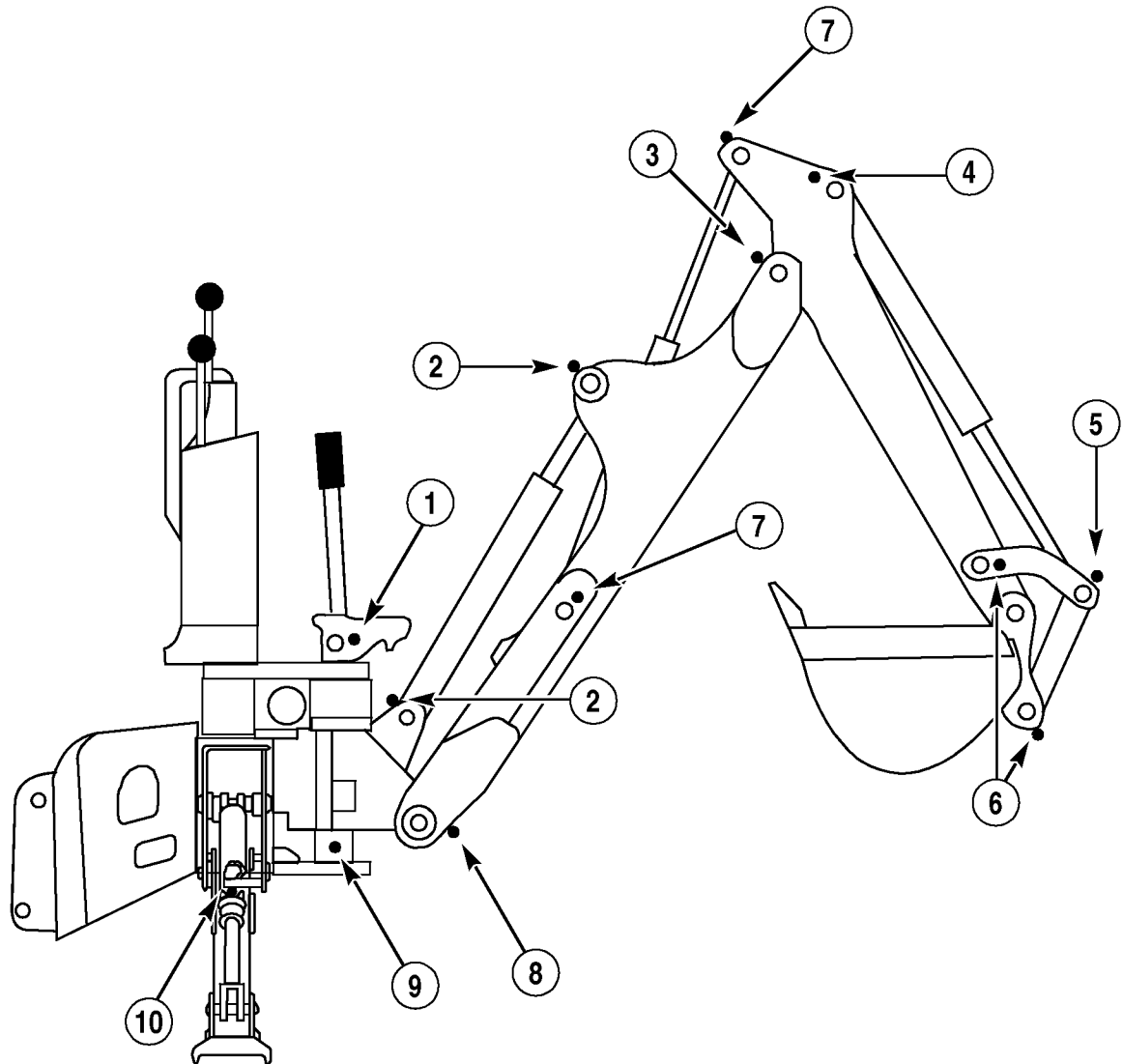

ts98h009

IF YOU OPERATE THE MACHINE IN SEVERE CONDITIONS, LUBRICATE AND SERVICE THE MACHINE MORE FREQUENTLY. IT IS RECOMMENDED THAT YOU SEE YOUR **CASE** DEALER FOR INFORMATION ON THE SYSTEMGARD LUBRICATION SYSTEM.

SEE YOUR OPERATORS MANUAL FOR MAINTENANCE OF SAFETY RELATED ITEMS AND FOR DETAILED INFORMATION OF THE SERVICE ITEMS ON THIS CHART. OPERATORS AND SERVICE MANUALS ARE AVAILABLE FOR THIS MACHINE FROM YOUR **CASE** DEALER.

2000

ENGINE AND RADIATOR REMOVAL AND INSTALLATION

TABLE OF CONTENTS

Engine Removal	2000-2	Illustration of Radiator and Oil Cooler Installation	2000-17
Engine Installation	2000-10	Radiator Installation	2000-20
Radiator Removal	2000-17		

ENGINE REMOVAL

1. Open the rear door.

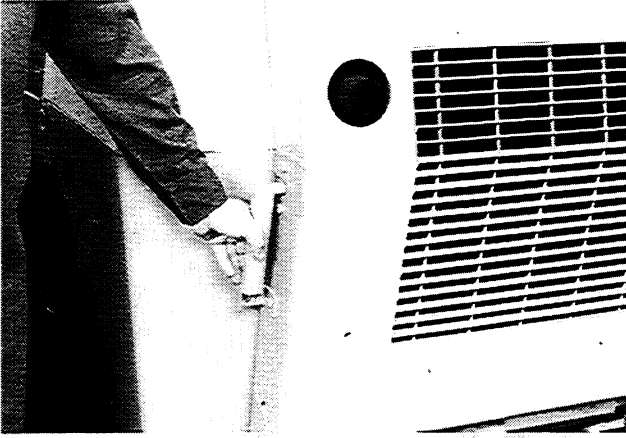

2. Raise the rear cover.

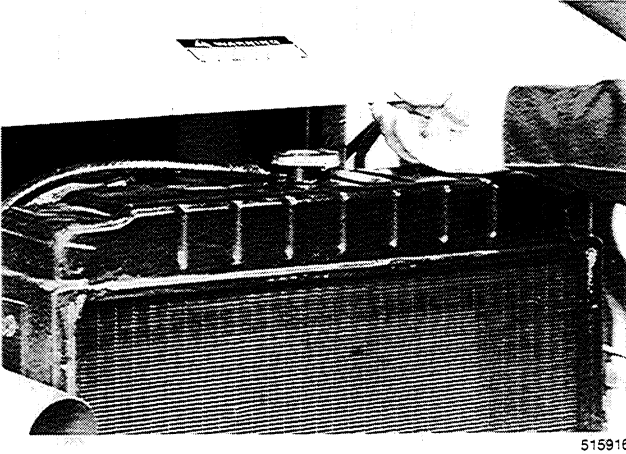

3. Loosen and remove the radiator cap.

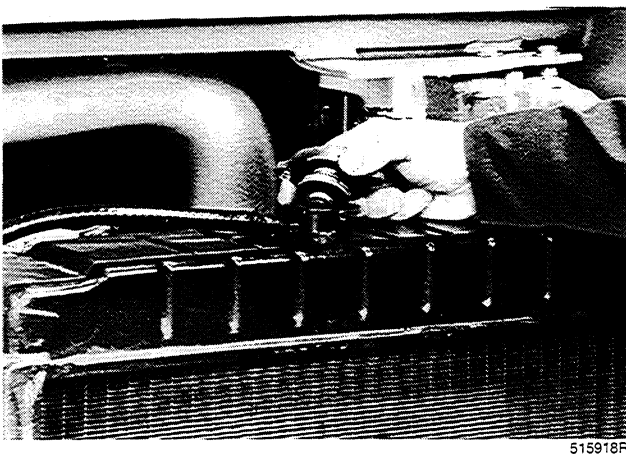

4. Open the drain valve at the LH bottom side of the radiator and drain the cooling system. The cooling system contains approximately 18.2 quarts (17.2 litres) of coolant.

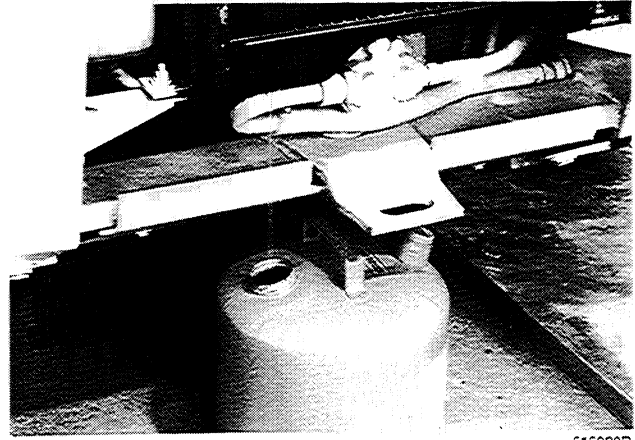

5. Drain the coolant reservoir. Loosen the clamp for the hose on the coolant reservoir and disconnect the hose to drain the coolant reservoir.

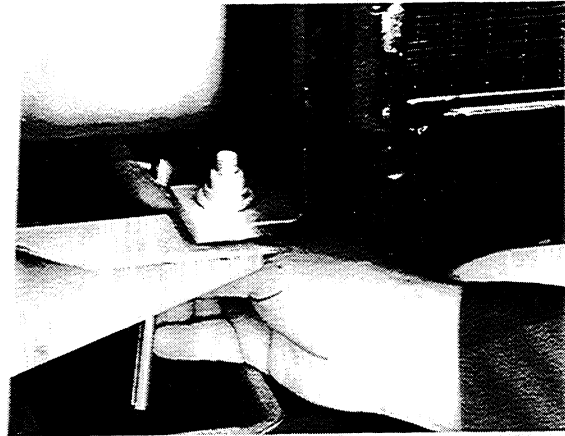

6. Loosen the clamp on the top radiator hose and disconnect the hose.



7. Loosen the clamp on the bottom radiator hose.

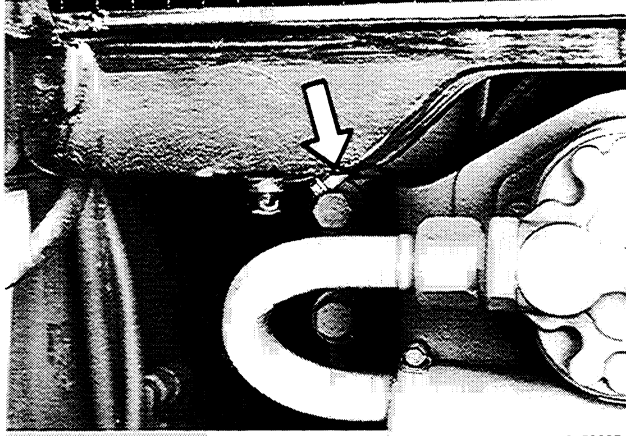

8. Loosen and remove the cap screws, bolts, lock washers, flat washers, and nuts that hold the radiator in place.

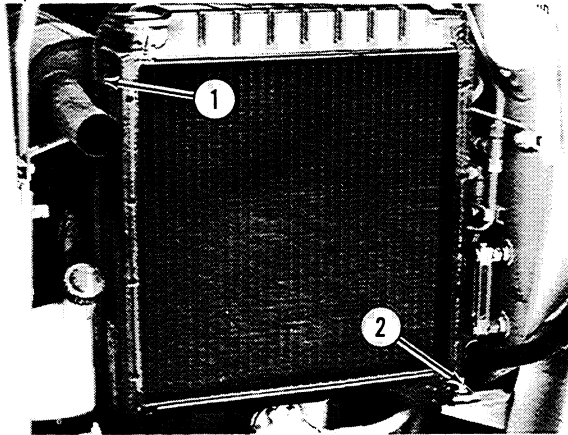

- 1. Cap Screws
- 2. Bolts

9. Pull the radiator to the rear to disconnect the bottom radiator hose, and remove the radiator from the machine.

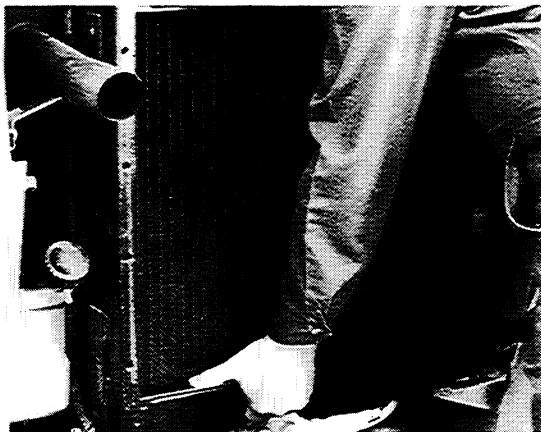

10. Move the operators compartment forward according to the instructions in Section 9003.

11. If equipped with a precleaner:

a. Loosen the clamp and disconnect the hose for the precleaner.

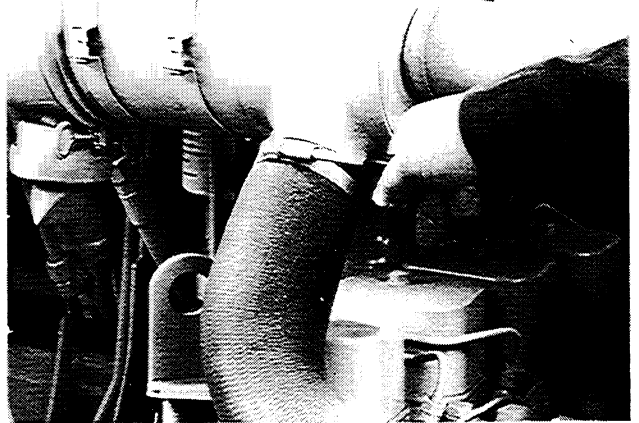

b. Loosen and remove the nuts, lock washers, and bolts that hold the tube for the pre-cleaner to the frame. Remove the hose, tube, and pre-cleaner.

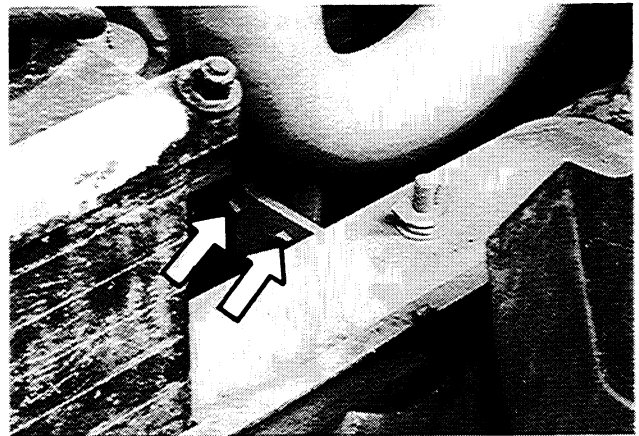

12. Loosen the clamp on the hose at the intake manifold. Remove the hose.



13. Cover or close the opening in the intake manifold.

14. Loosen and remove the nuts and bolts that fasten the air cleaner to the bracket. Remove the air cleaner.

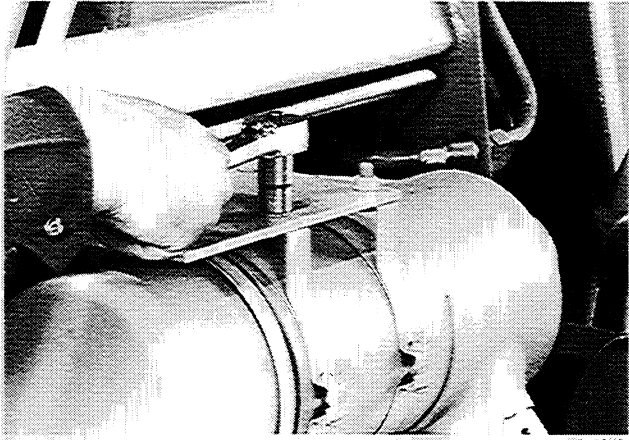

515940

15. If equipped with ether injection:

a. Disconnect the tube from the intake manifold.

b. Disconnect the wire for the thermostat.

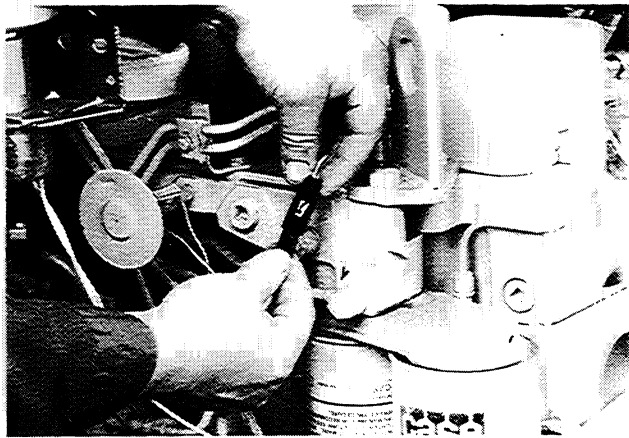

515901

c. Disconnect the wire to the valve assembly.

d. Loosen and remove nuts, lock washers, bolts, and flat washers that fasten the bracket. Remove the bracket.

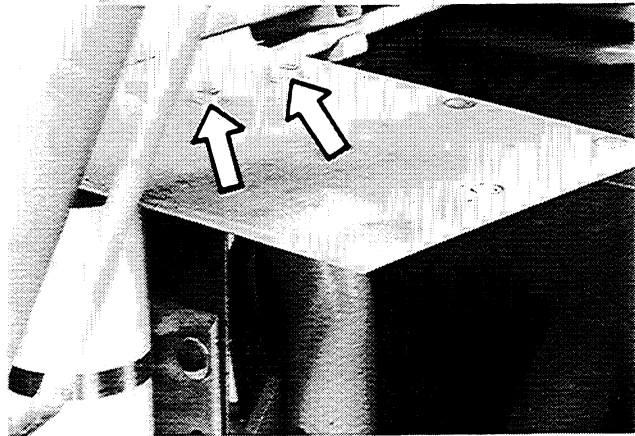

515903

16. Loosen and remove the cap screws and lock washers that hold the muffler to the exhaust manifold. Remove the muffler.

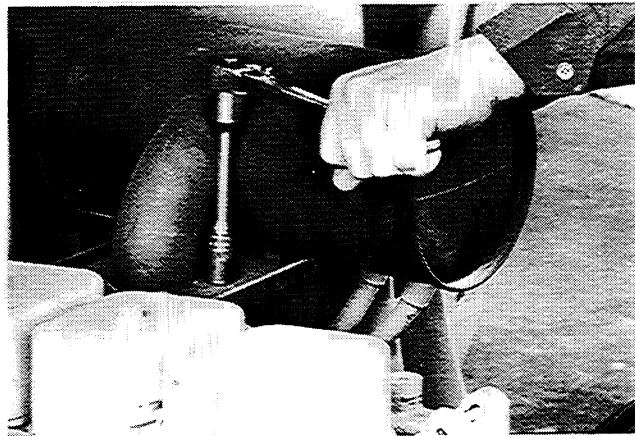

516008

17. Cover or close the opening in the exhaust manifold.

18. Disconnect the ground cable from the battery.



516010

19. Loosen and remove the cap screw and lock washers that fasten the wiring harness, and ground cable to the cover on the flywheel housing. Remove the ground cable.



20. Disconnect the positive cable from the battery terminal on the starter solenoid.

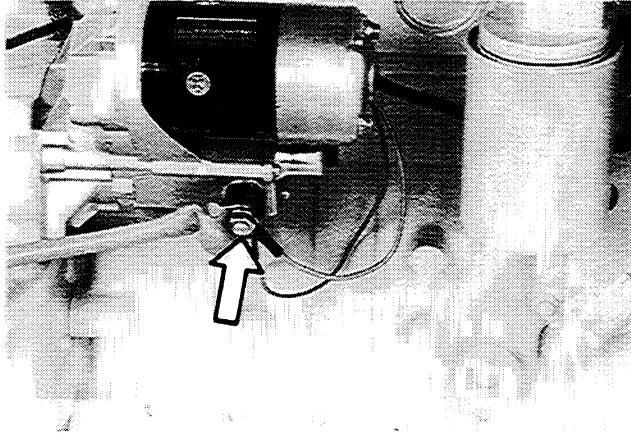

21. Disconnect the wire from the fuel level sender.

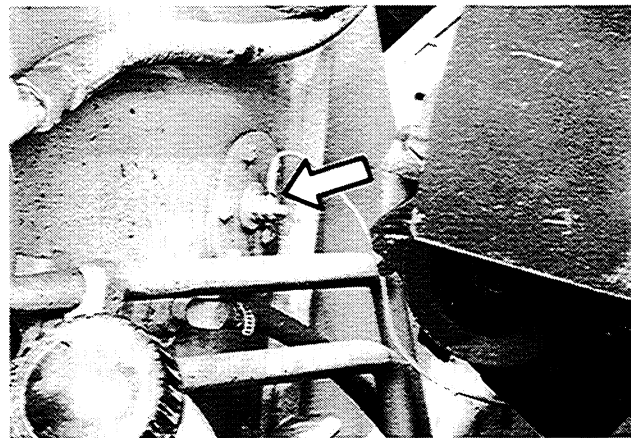

22. Close the shutoff valve for the fuel supply line.

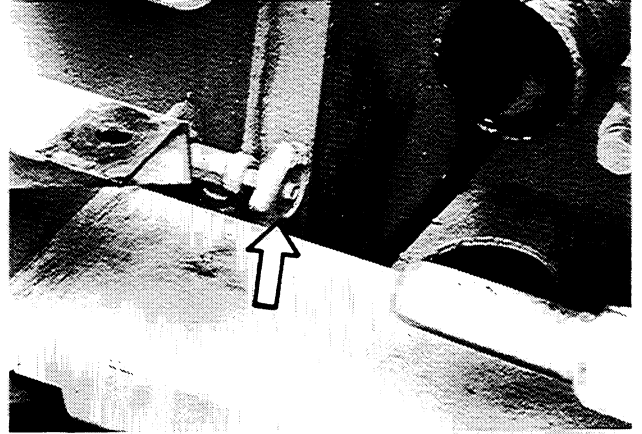

23. Loosen and remove the cap screws and lock washers that hold the equipment pump to the rear engine mount.

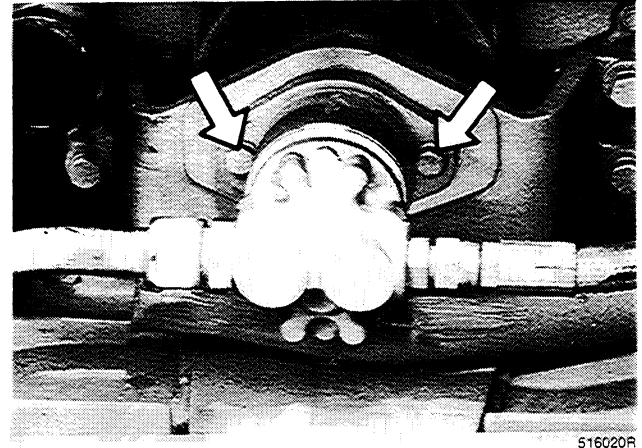

24. Pull the equipment pump away from the rear engine mount to disengage the drive shaft of the equipment pump from the coupling on the crankshaft pulley.

25. Disconnect the wire from the hydraulic oil filter.



26. Loosen the clamp and disconnect the fuel supply hose from the hand primer pump. Loosen the clamp and disconnect the hose from the fuel return line.

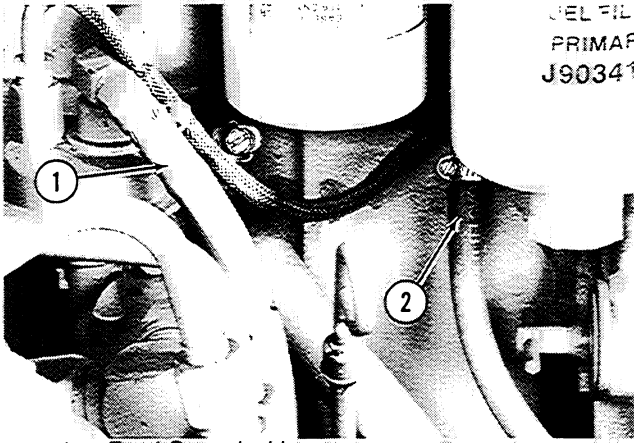

- 1. Fuel Supply Hose
- 2. Fuel Return Hose

516024

27. Install plugs in the hoses.

28. Loosen and remove the cap screw, lock washer, and flat washer that fasten the ground wire from the bracket for the loader valve to the cover on the flywheel housing.

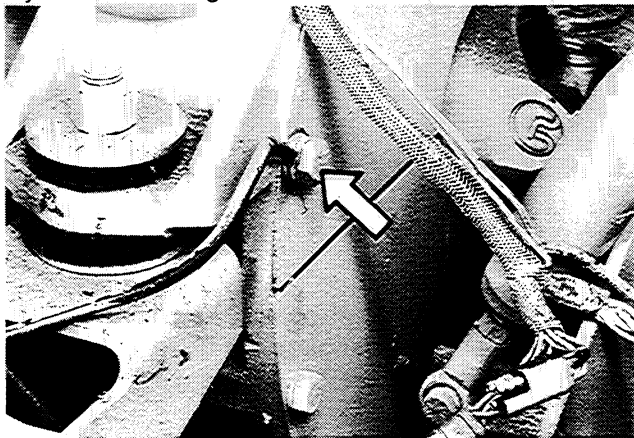

516026

29. Disconnect the wire from the charge pressure switch.

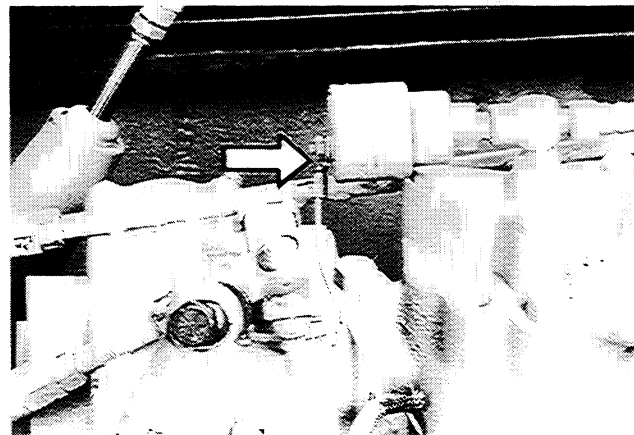

516028

30. Disconnect the wire from the oil temperature switch.



516030

31. Loosen and remove the self-locking nuts, flat washers, and bolts that hold the front engine mounts to the frame.

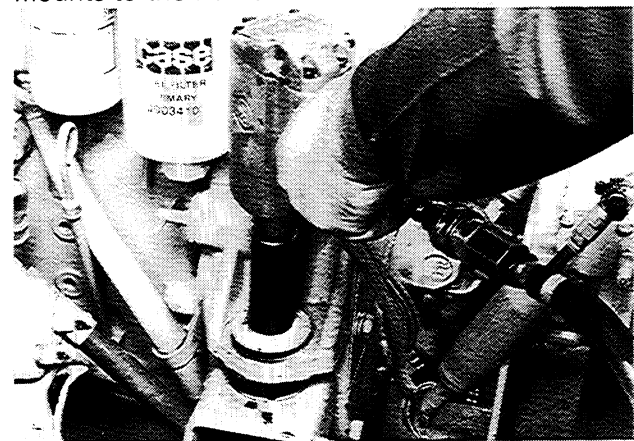

516223

32. Loosen and remove the cap screws, self-locking nut, flat washer, and bolt that fasten the oil fill tube and the clamp for the oil fill tube to the engine. Remove the oil fill tube.

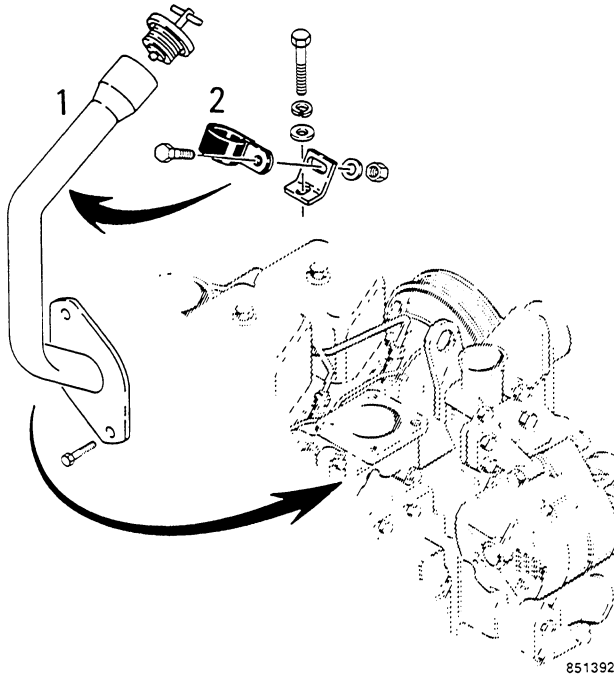

1. Oil Fill Tube 2. Clamp

33. Loosen the clamp for the top radiator hose. Remove the hose.

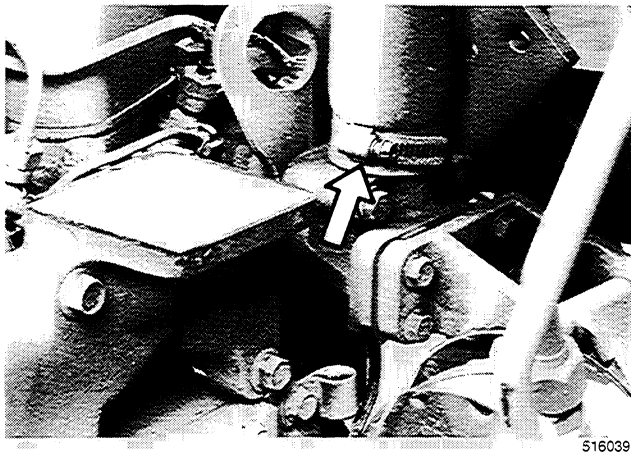

34. Connect acceptable lifting equipment to the lifting eyes on the engine.

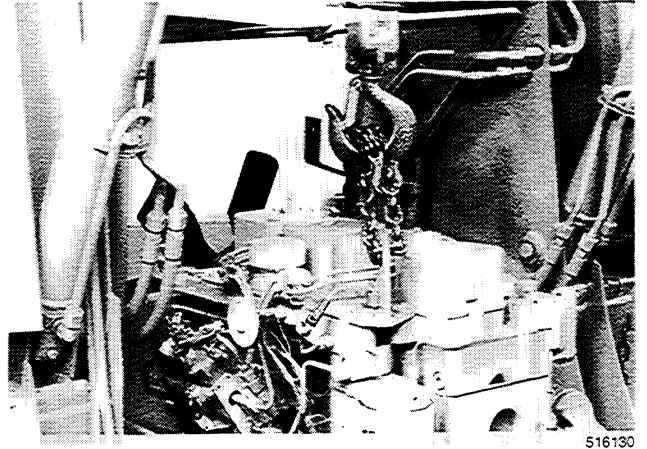

35. Remove the access cover from the guard below the rear engine mount.

36. Loosen and remove the cap screw and flat washer that hold the rear engine mount to the frame.

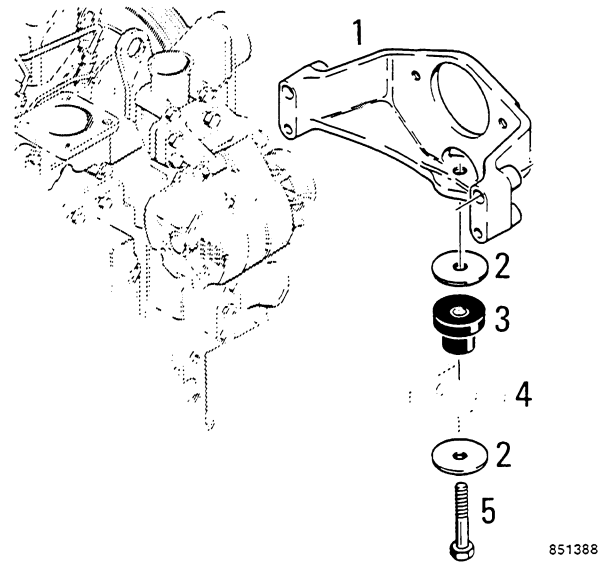

1. Rear Engine Mount 4. Frame
2. Flat Washer 5. Cap Screw
3. Insulator

37. Move the engine toward the rear to disengage the drive coupling on the flywheel from the drive shaft on the tandem pump.

38. Raise the engine.

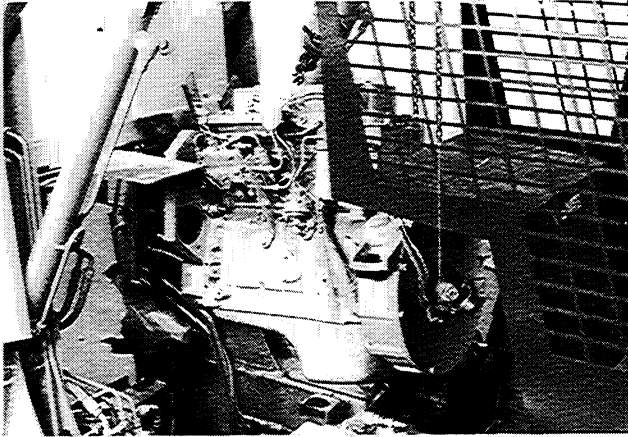

516215

39. Turn the engine in the direction shown and carefully raise the engine.

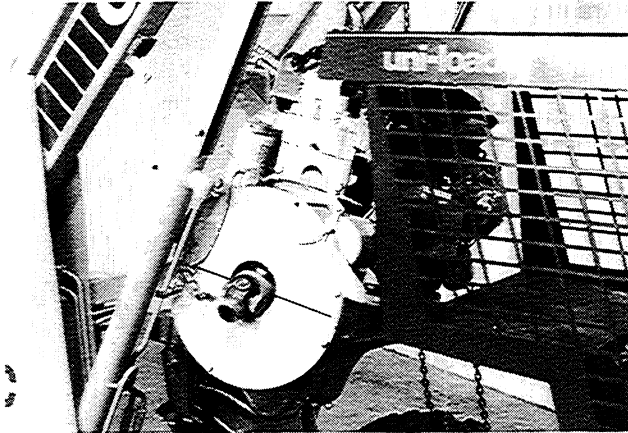

516213

40. Turn the engine toward the rear of the machine.



516106

41. Remove the engine from the machine.



516104

42. If necessary, remove the wiring harness from the engine.

a. Disconnect the wire from the water temperature switch at the top rear of the engine.

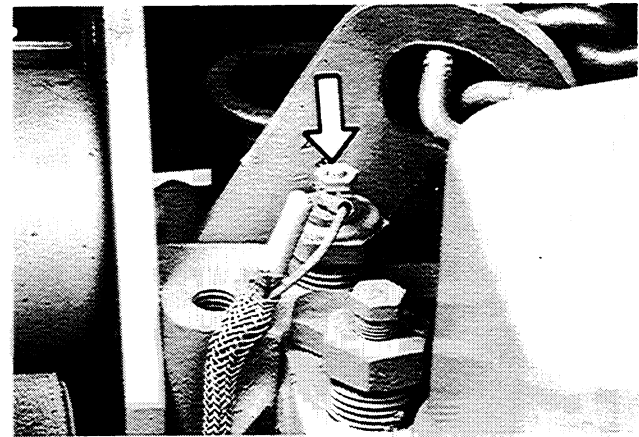

516137

b. Disconnect the wires from the alternator. Disconnect the plug from the alternator. Disconnect the wire from the Switch terminal and disconnect the wire from the Battery terminal on the starter solenoid.

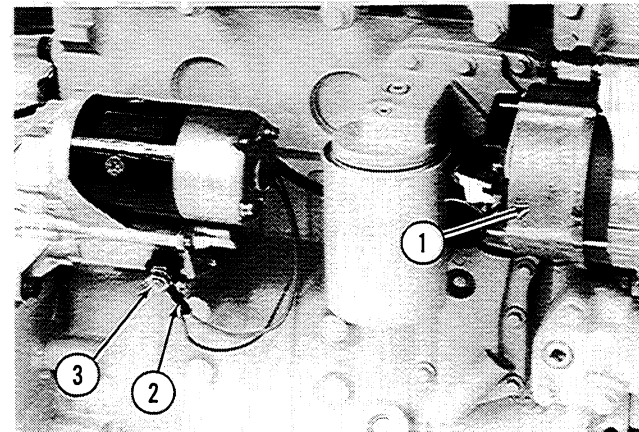

856630

1. Alternator
2. Switch Terminal
3. Battery Terminal

c. Disconnect the wire from the fuel injection solenoid on the fuel injection pump. Disconnect the wire from the engine oil pressure switch. Disconnect the wires from the restriction indicator switch.

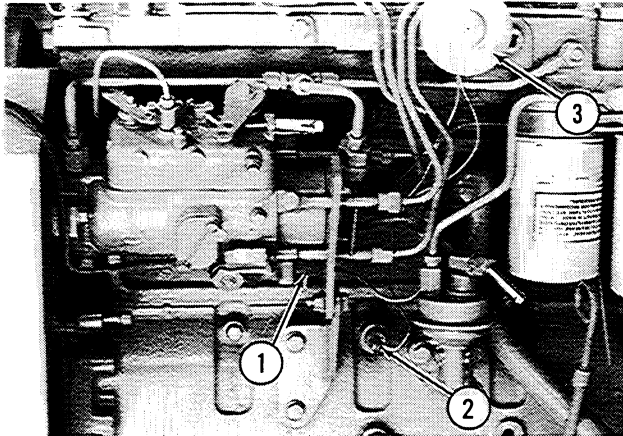

1. Fuel Injection Solenoid
2. Engine Oil Pressure Switch
3. Restriction Indicator Switch

516134

d. Loosen and remove the cap screws that fasten the wiring harness to the rear of the engine and flywheel cover. Disconnect the wires from the resistor on the flywheel cover.

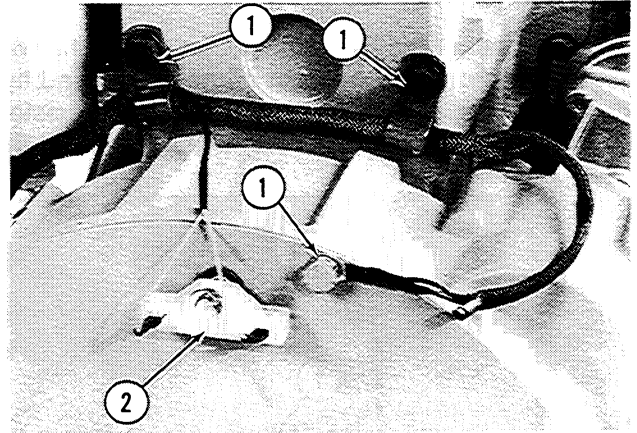

1. Cap Screw
2. Resistor

856632

ENGINE INSTALLATION

1. If the wiring harness was removed from the engine, install the wiring harness.

a. Install the cap screws that fasten the wiring harness to the front of the engine and fly-wheel cover. Connect the wires to the resistor. Tighten the two cap screws at the front of the engine.

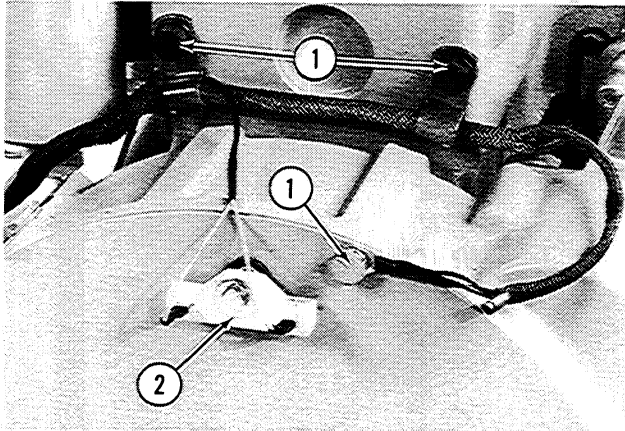

1. Cap Screw
2. Resistor

856632

b. Connect the wire to the fuel injection solenoid on the fuel injection pump. Connect the wire to the engine oil pressure switch. Connect the wires to the restriction indicator switch.

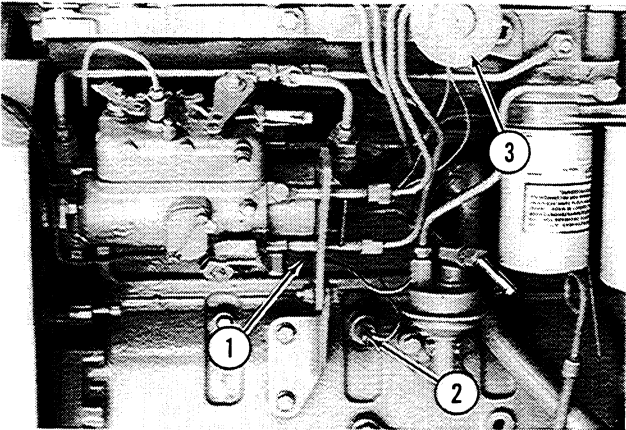

1. Fuel Injection Solenoid
2. Engine Oil Pressure Switch
3. Restriction Indicator Switch

516134

c. Connect the wires to the alternator. Connect the plug to the alternator. Connect the wire to the Switch terminal and connect the wire to the Battery terminal on the starter solenoid.

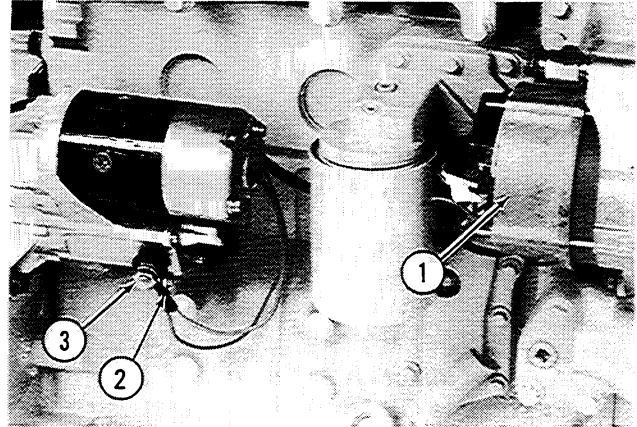

1. Alternator
2. Switch Terminal
3. Battery Terminal

856630

d. Connect the wire to the water temperature switch at the top rear of the engine.

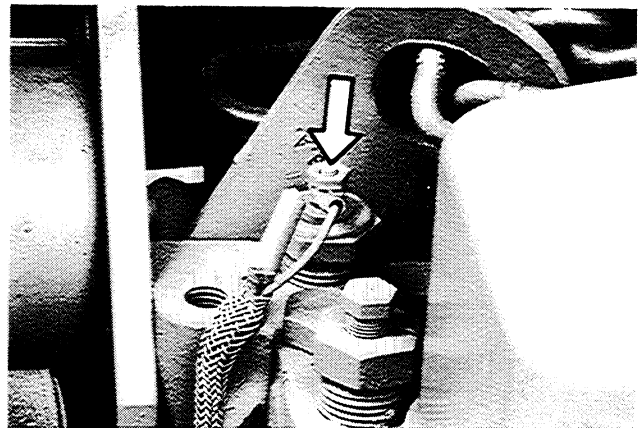

516137

2. Lift the engine over the machine.



516104

3. Push the engine toward the front of the machine.

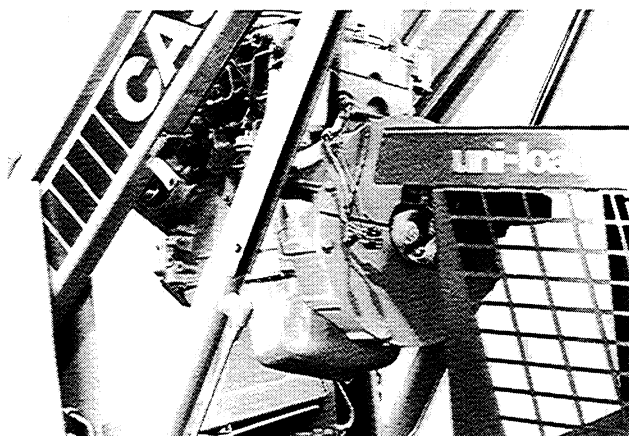

516106

4. Lower the engine and turn the engine in the direction shown.

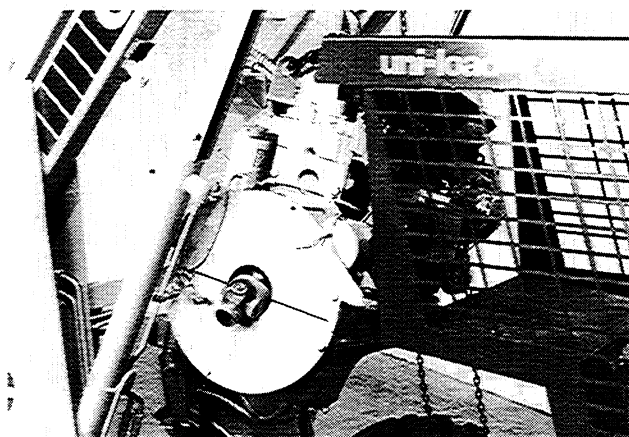

516213

5. Lower the engine into the machine, and move the engine toward the rear.

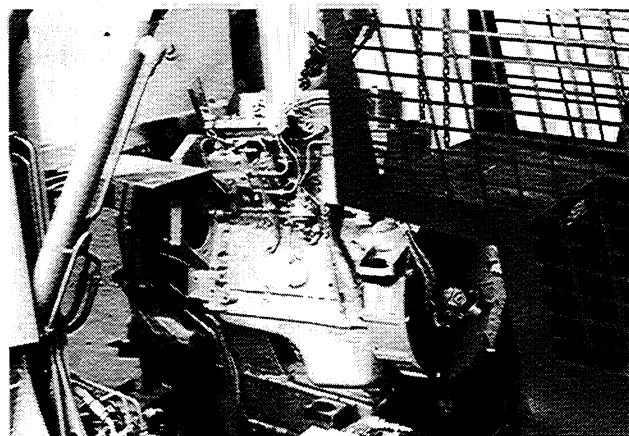

516215

6. Engage the drive coupling on the flywheel with the drive shaft on the tandem pump and push the engine forward.

7. Make sure the flat washers are installed between the frame and the front and rear engine mounts.

8. Lower the engine into place.

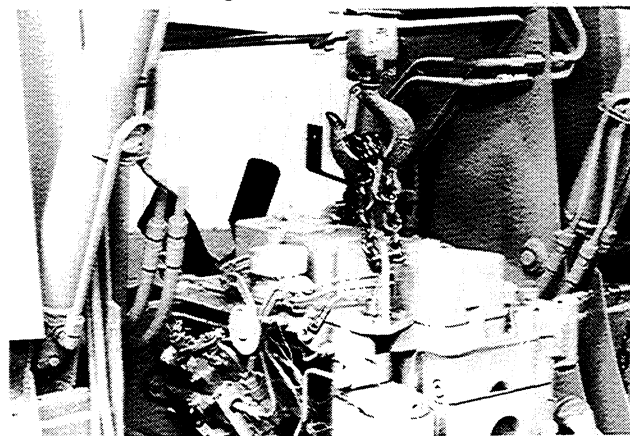

516130

9. Install the bolts, flat washers, and self-locking nuts that hold the front engine mounts to the frame. Tighten the self-locking nuts to 150 to 180 pound-feet (203 to 244 N m, 20.8 to 24.9 kg/m).

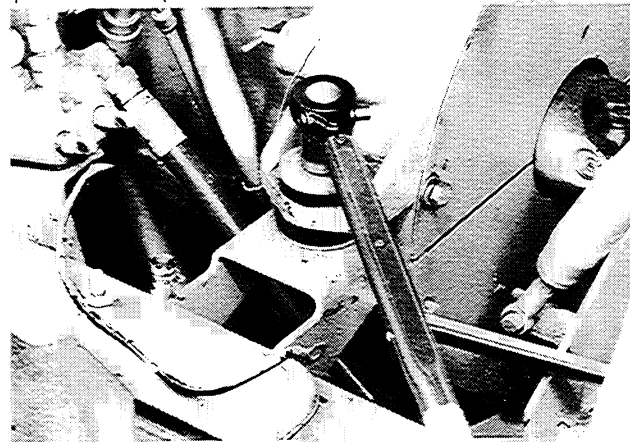

516032

10. Install the cap screw and flat washer that holds the rear engine mount to the frame. Tighten the cap screw to 200 to 240 pound-feet (270 to 325 N m, 27.6 to 33.2 kg/m).

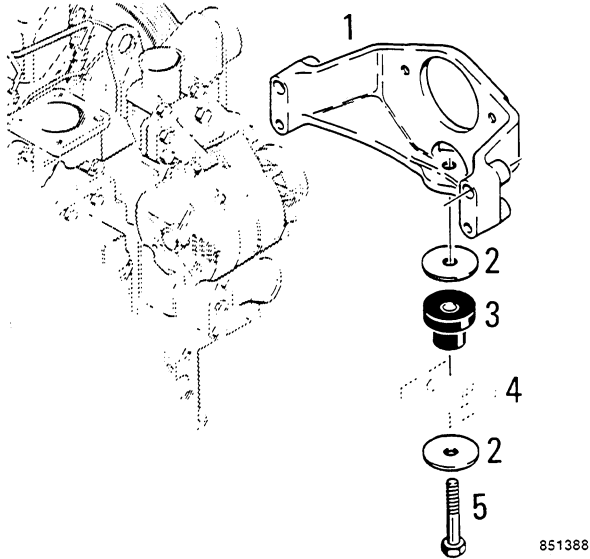

- 1. Rear Engine Mount
- 2. Flat Washer
- 3. Insulator
- 4. Frame
- 5. Cap Screw

11. Install the access cover in the guard below the rear engine mount.

12. Disconnect the lifting equipment from the engine.

13. Install the top radiator hose and tighten the clamp.



14. Install the oil fill tube. Install the cap screws, bolt, flat washer, and self-locking nut that fasten the oil fill tube and the clamp for the oil fill tube to the engine. Tighten the cap screws and self-locking nut.

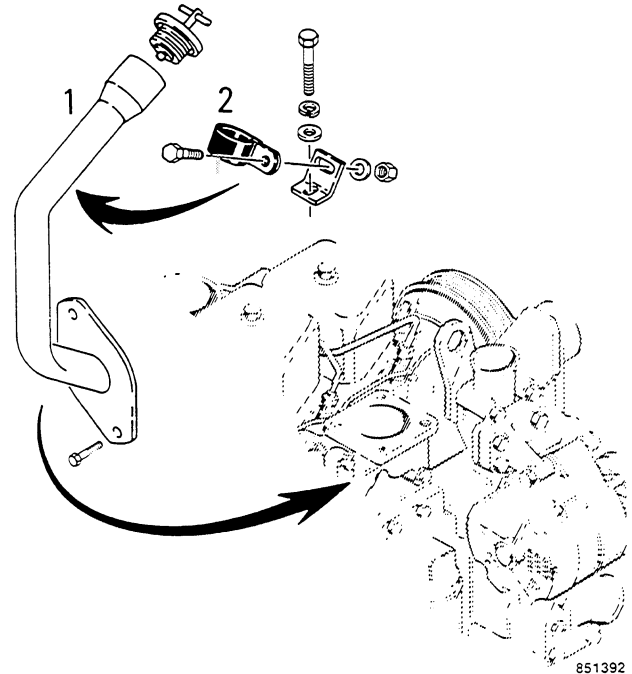

- 1. Oil Fill Tube
- 2. Clamp

15. Connect the wire to the oil temperature switch.



16. Connect the wire to the charge pressure switch.

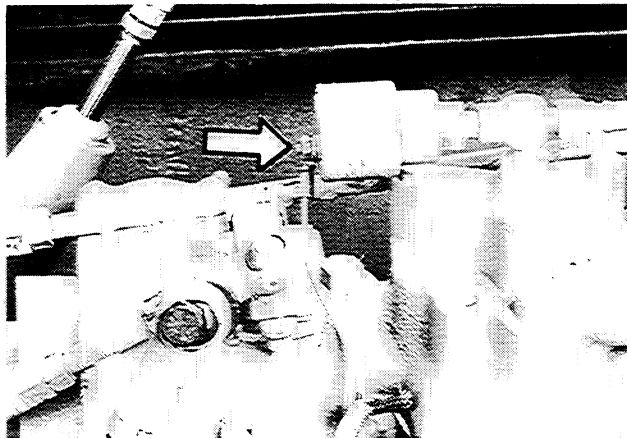

516028

19. Connect the wire to the hydraulic oil filter.

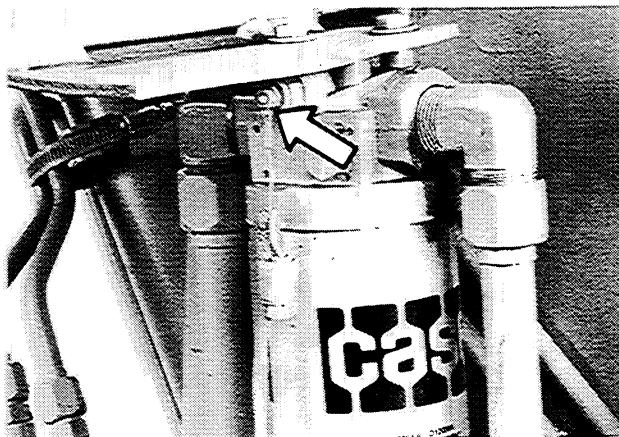

516022R

17. Install the cap screw, lock washer, and flat washer that fasten the ground wire from the bracket for the loader valve to the cover on the flywheel housing. Tighten the cap screw.

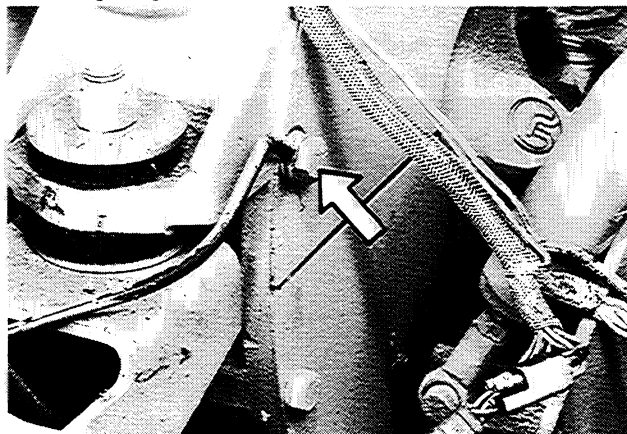

516026

20. Engage the drive shaft of the equipment pump with the coupling on the crankshaft pulley. Push the equipment pump against the rear engine mount and install the cap screws and lock washers. Tighten the cap screws.

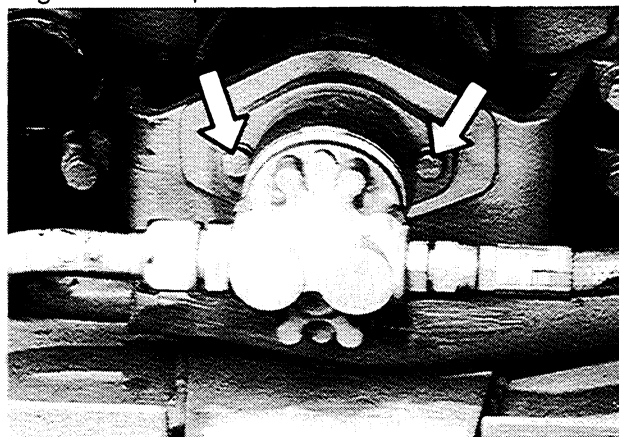

516020R

18. Connect the hose to the fuel return line and tighten the clamp. Connect the fuel supply hose to the hand primer pump and tighten the clamp.

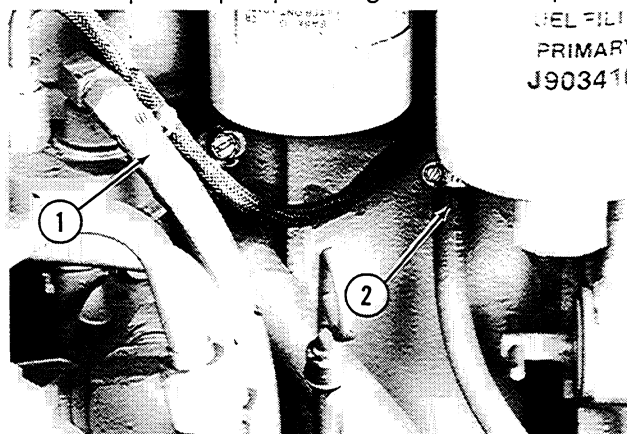

516024

- 1. Fuel Supply Hose
- 2. Fuel Return Hose

21. Open the shutoff valve for the fuel supply line.

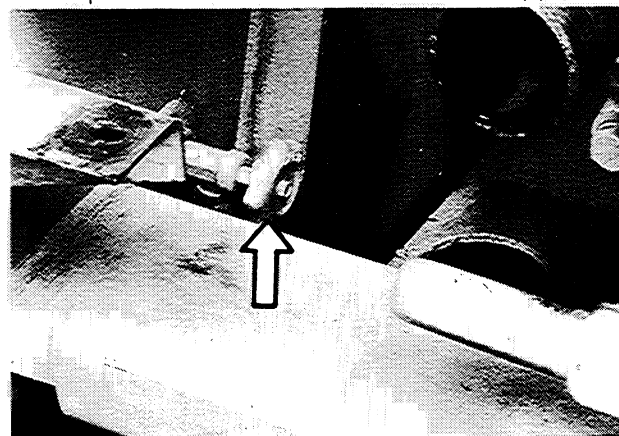

516018

22. Connect the wire to the fuel level sender.

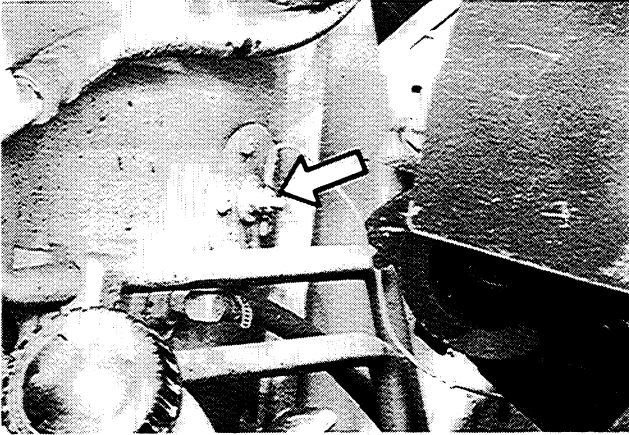

516016

23. Connect the positive cable to the Battery terminal on the starter solenoid.

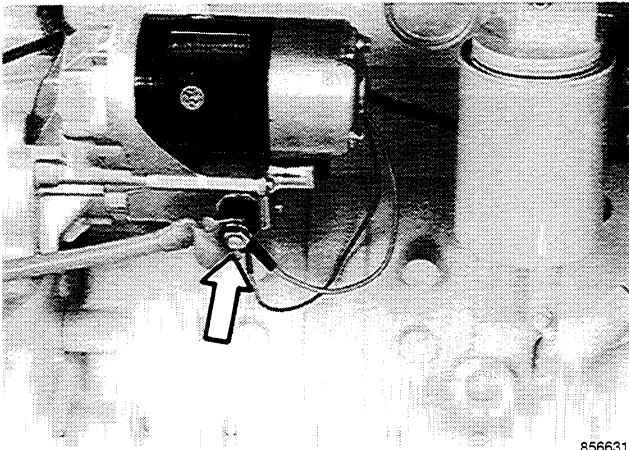

856631

24. Remove the cap screw from the flywheel cover and install the ground cable and wiring harness in place. Install the cap screw and lock washer and tighten the cap screw.

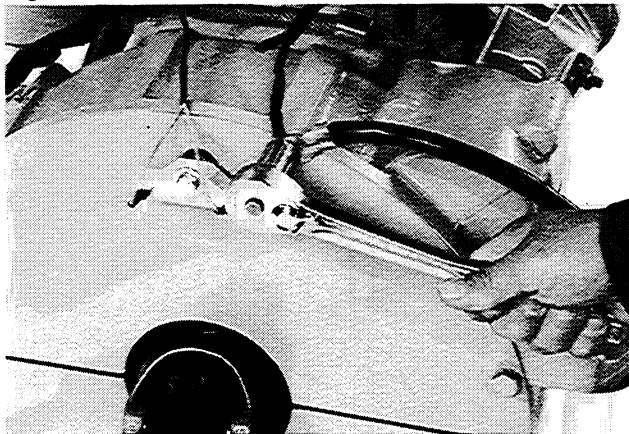

856634

25. Connect the ground cable to the battery.



516010

26. Remove the tape or cover from the opening for the exhaust manifold.

27. Check the condition of the gasket for the muffler and install a new gasket as required.

28. Install the muffler. Install and tighten the cap screws and lock washers that hold the muffler.



516008

29. If equipped with ether injection:

- a. Install the bracket. Install the bolts, flat washers, lock washers, and nuts. Tighten the nuts.

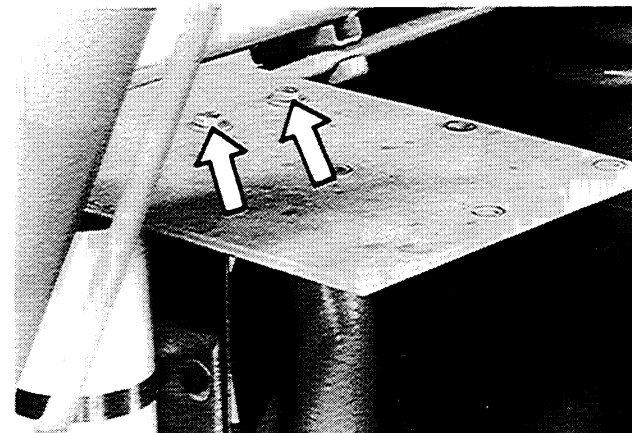

515903

- b. Connect the wire for the valve assembly.
- c. Connect the wire for the thermostat.

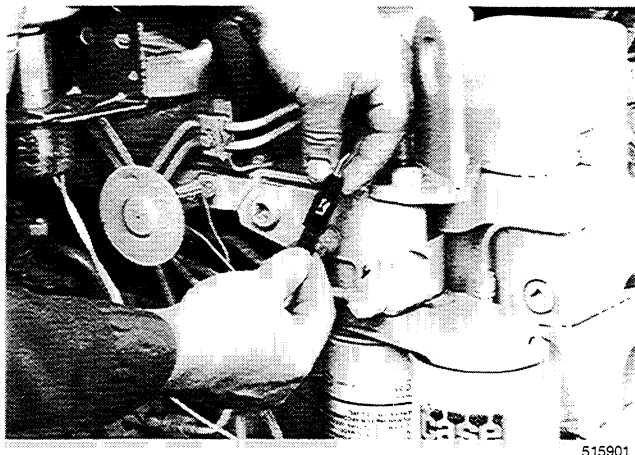

515901

- d. Connect the tube to the intake manifold.

30. Install the air cleaner. Install and tighten the nuts and bolts that hold the air cleaner to the bracket.

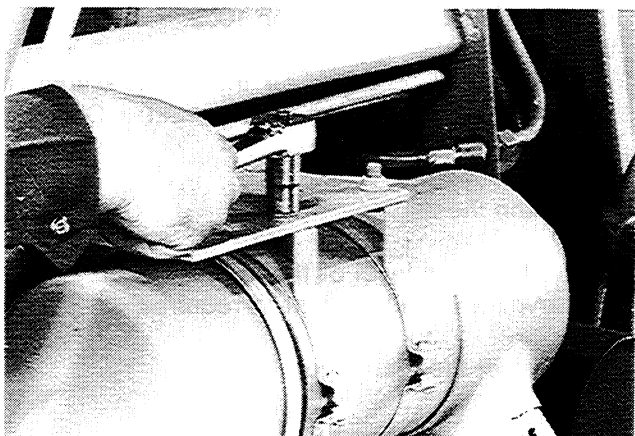

515940

31. Remove the tape or cover from the opening for the intake manifold.

32. Install the air cleaner hose and tighten the clamp.



515938

33. If equipped with a precleaner:

- a. Install the hose, tube, and precleaner. Install the bolts, lock washers, and nuts that hold the tube for the precleaner to the frame. Tighten the nuts.

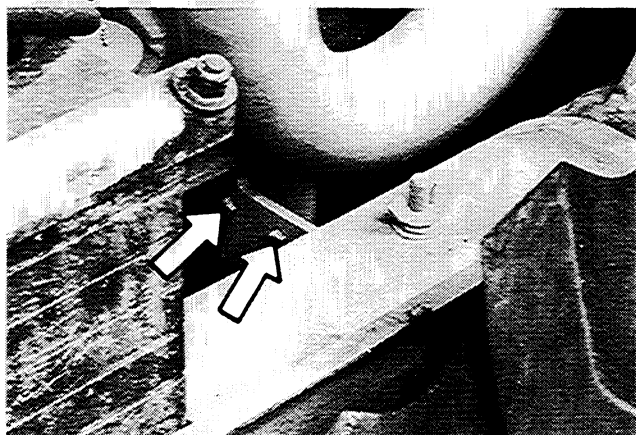

515934

- b. Install the hose to the air cleaner and tighten the clamp.

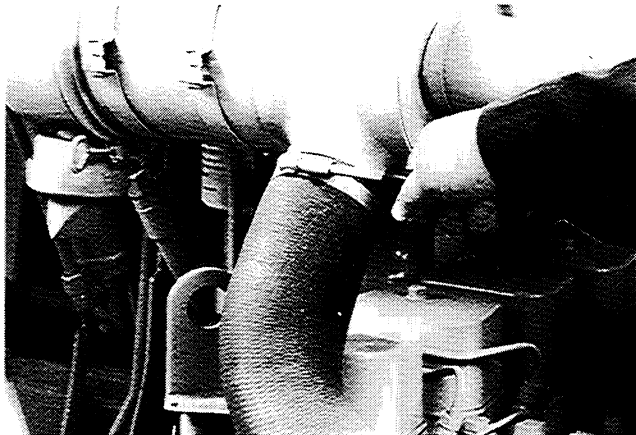

515932

34. Fasten the operators compartment in operating position according to the instructions in Section 9003.

35. Install the radiator and connect the bottom radiator hose.

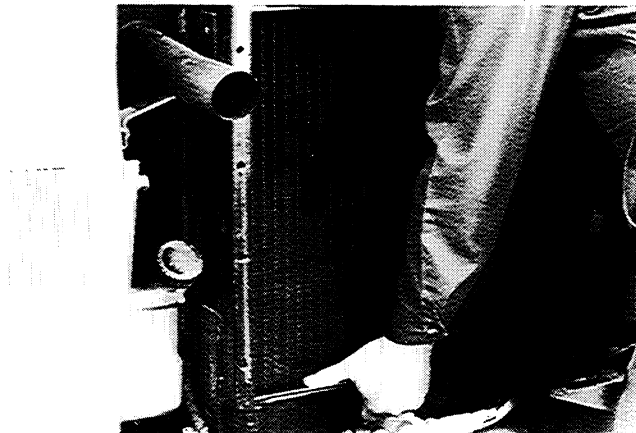

515930R

36. Install the cap screws, bolts, lock washers, flat washers, and nuts that hold the radiator. Tighten the cap screws. Tighten the bolts to 15 to 20 pound-inches (1.68 to 2.25 N m, 0.17 to 0.23 kg/m).

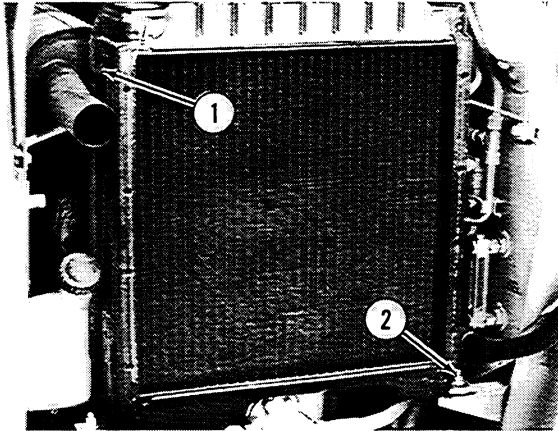

1. Cap Screws
2. Bolts

515928R

37. Tighten the clamp for the bottom radiator hose.

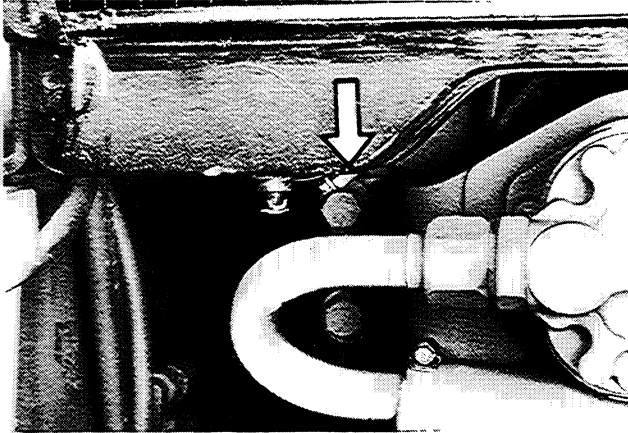

515926R

38. Connect the hose for the coolant reservoir and tighten the clamp.

39. Connect the top radiator hose and tighten the clamp.

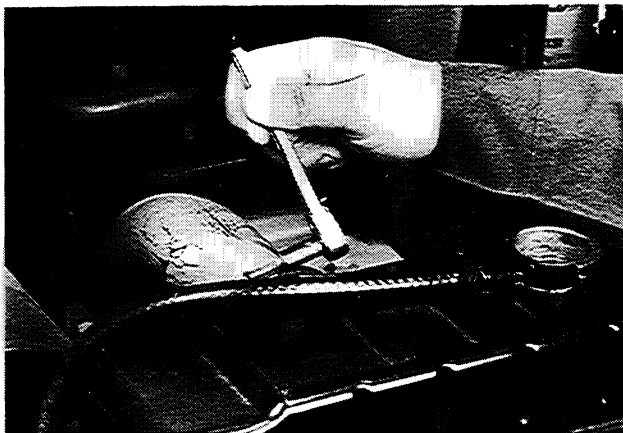

515924

40. Close the drain valve in the radiator and fill the radiator with coolant. See Section 1002 for coolant specifications.

41. Install the radiator cap.

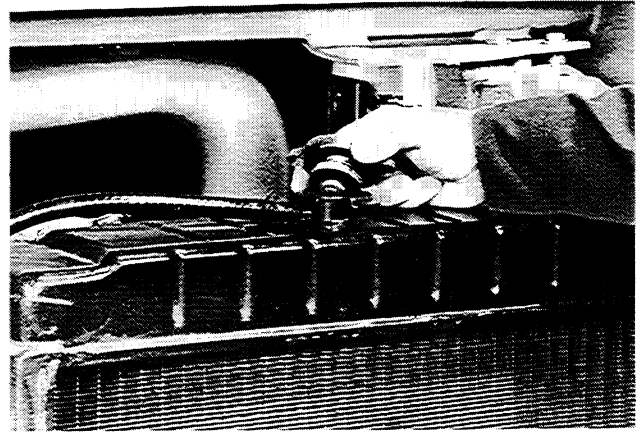

515918R

42. Fill the coolant reservoir to the FULL mark.

43. Make sure that the crankcase has been filled with engine oil. See Section 1002.

44. Start the engine and run the engine at idle until the engine is at operating temperature. Check for coolant and fuel leaks.

45. Stop the engine.

46. Check the level of the coolant in the coolant reservoir and add coolant as required.

47. Lower the rear cover.

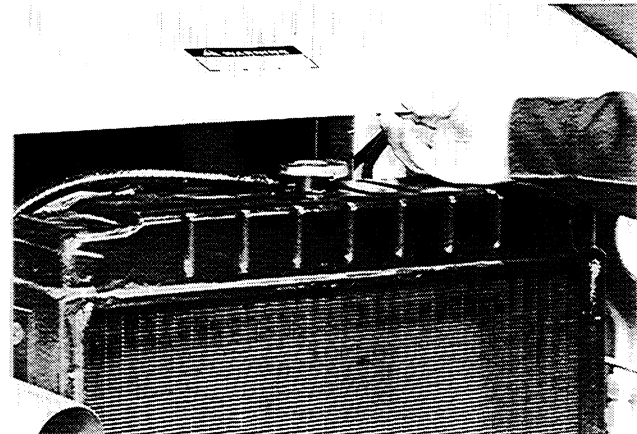

515916

48. Close the rear door.

1. Open the rear door.

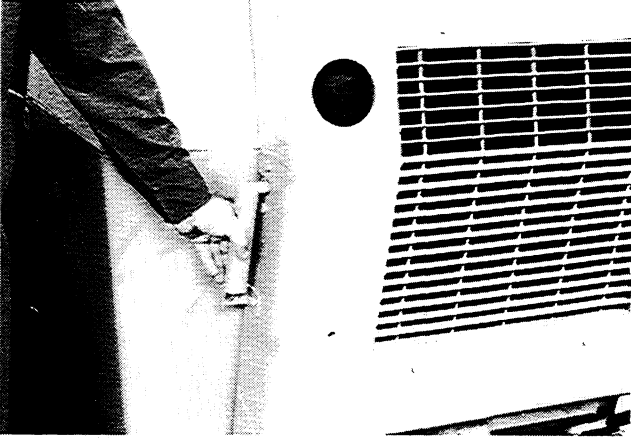

2. Raise the rear cover.

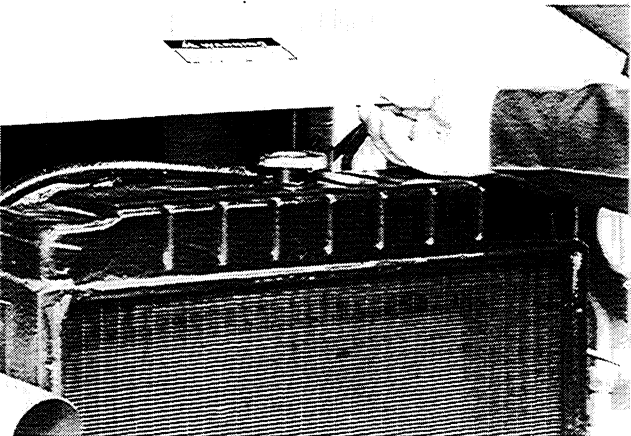

3. Loosen and remove the radiator cap.

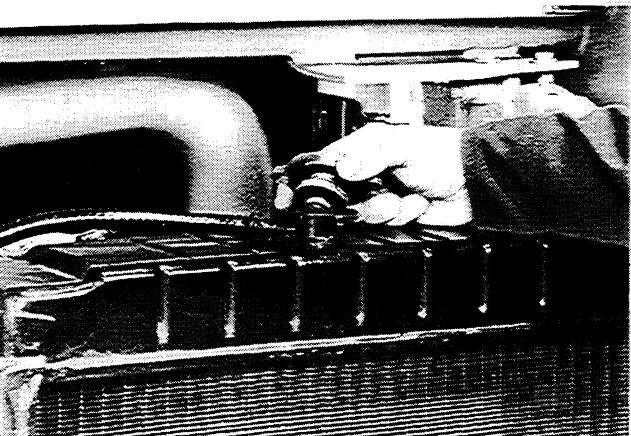

4. Open the drain valve at the LH bottom side of the radiator and drain the cooling system. The cooling system contains approximately 18.2 quarts (17.2 litres) of coolant.

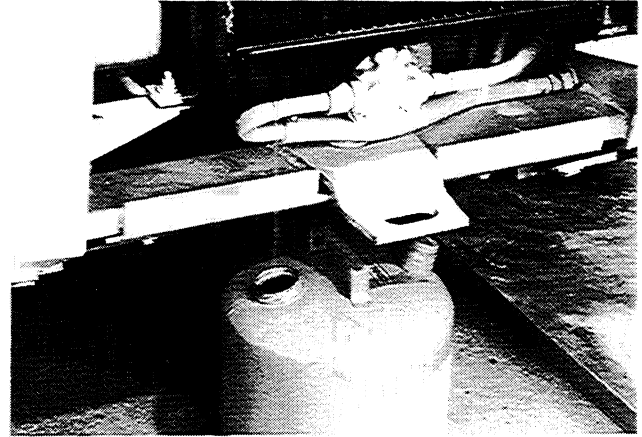

5. Drain the coolant reservoir. Loosen the clamp for the hose on the coolant reservoir and disconnect the hose to drain the coolant reservoir.

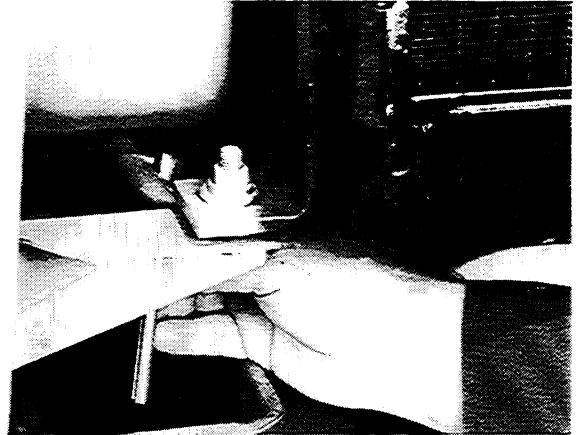

6. Loosen the clamp on the top radiator hose and disconnect the hose.

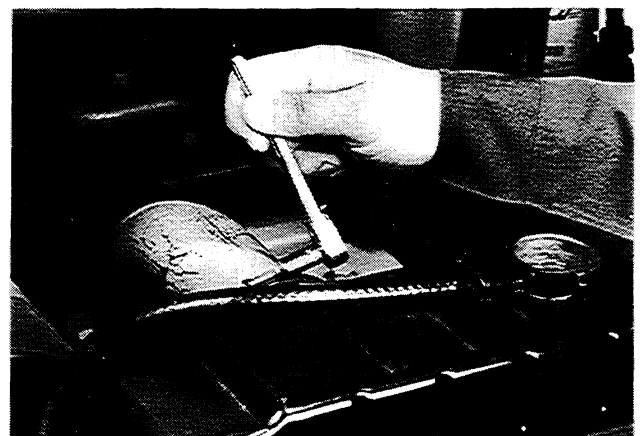

7. Loosen the clamp on the bottom radiator hose.

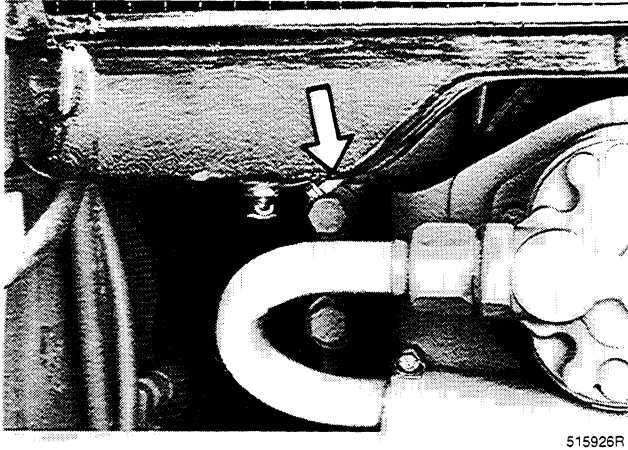

8. Loosen and remove the cap screws, bolts, lock washers, flat washers, and nuts that hold the radiator in place.

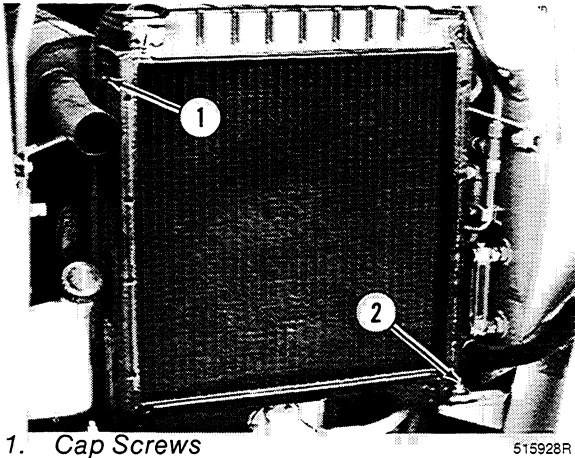

- 1. Cap Screws
- 2. Bolts

9. Pull the radiator to the rear to disconnect the bottom radiator hose, and remove the radiator from the machine.

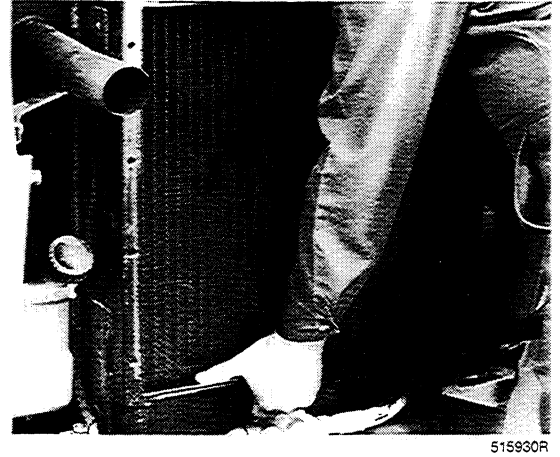

10. If the radiator is being removed for repair or cleaning:

- a. Disconnect the hose from the fill opening on the radiator.
- b. Loosen and remove the cap screws, lock washers, and flat washers that fasten the clamps for the hose and the fan shroud to the radiator.
- c. Remove the hose and fan shroud from the radiator.

RADIATOR INSTALLATION

1. Check the condition of the insulators in each radiator mount and install new insulators as required.

2. If the radiator was removed for repair or cleaning, or a new radiator is being installed:

- a. Install the fan shroud and hose.
- b. Install the cap screws, lock washers, clamps, and flat washers that fasten the fan shroud and hose to the radiator. Tighten the cap screws.
- c. Connect the hose to the fill opening.

3. Install the radiator and connect the bottom radiator hose.



4. Install the cap screws, bolts, lock washers, flat washers, and nuts that hold the radiator. Tighten the cap screws. Tighten the bolts to 15 to 20 pound-inches (1.68 to 2.25 N m, 0.17 to 0.23 kg/m).

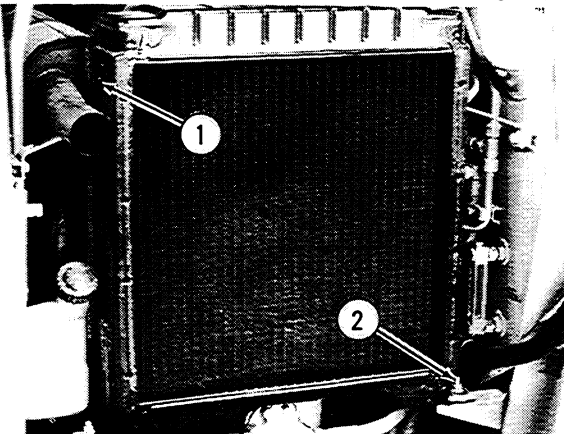

1. Cap Screws
2. Bolts

5. Tighten the clamp for the bottom radiator hose.

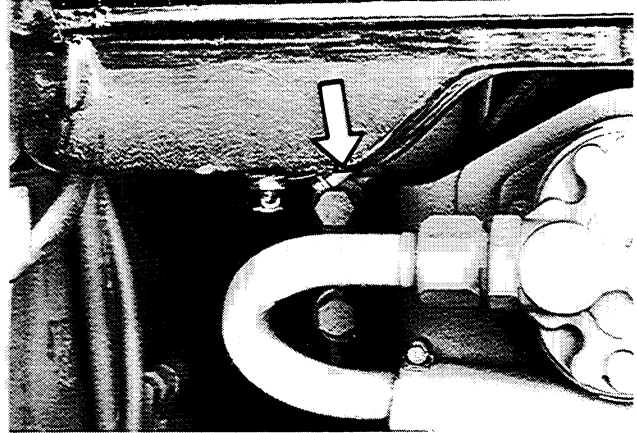

6. Connect the hose for the coolant reservoir and tighten the clamp.

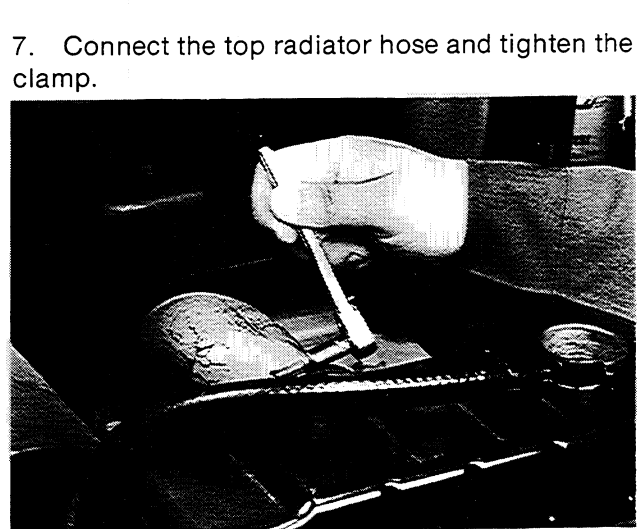

8. Close the drain valve in the radiator and fill the radiator with coolant. See Section 1002 for coolant specifications.

9. Install the radiator cap.

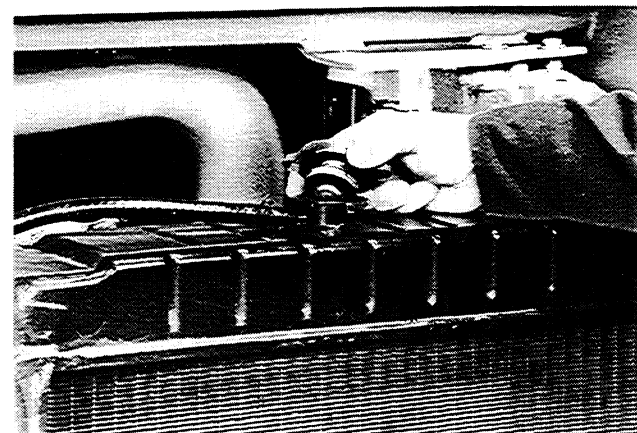

10. Fill the coolant reservoir to the FULL mark.
11. Start the engine and run the engine at idle until the engine is at operating temperature. Check for coolant leaks.
12. Stop the engine.
13. Check the level of the coolant in the coolant reservoir and add coolant as required.

14. Lower the rear cover.

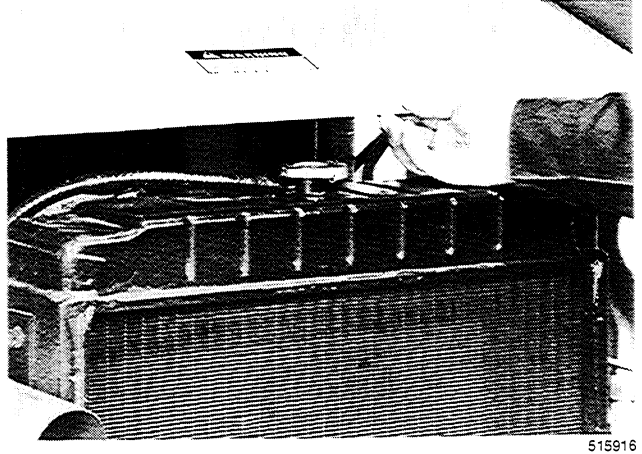

15. Close the rear door.

2001

ENGINE ACCESSORIES

TABLE OF CONTENTS

Air Cleaner	2001-2	Illustration of Air Cleaner Installation ..	2001-4
Service Interval	2001-2	Ether Injection System	2001-5
Cleaning the Primary Element	2001-2	General Information	2001-5
Secondary Element	2001-2	Operating Procedure	2001-5
Checking the Switch for the Air Filter Warning Lamp	2001-2	Troubleshooting	2001-5
Illustration of Air Cleaner	2001-3	Illustration of Ether Injection System ..	2001-6
		Spark Arrester Muffler	2001-7