

<https://caseihservicemanual.com>

2050M
Crawler Dozer

SERVICE MANUAL

Part number 48037321A

2nd edition English

June 2018

© 2018 CNH Industrial Latin America LTDA. All Rights Reserved.

CASE
CONSTRUCTION



SERVICE MANUAL

2050M XLT, With cab, Tier 2, Power Angle Tilt (PAT) Blade, Made in Brazil

2050M XLT, With cab, Tier 3, Power Angle Tilt (PAT) Blade, Made in Brazil

2050M XLT, With cab, Tier 3, Bulldozer (BD) Blade, Made in Brazil

2050M XLT, With cab, Tier 2, Bulldozer (BD) Blade, Made in Brazil

<https://caseihservicemanual.com>

Link Product / Engine

Product	Market Product	Engine
2050M XLT, com cabine, Tier 2, lâmina Power Angle Tilt (PAT), feito no Brasil	Latin America	F4HFA613N*E002
2050M XLT, com cabine, Tier 2, lâmina Bulldozer (BD), feito no Brasil	Latin America	F4HFA613N*E002

<https://caseih.servicemanual.com>

Contents

INTRODUCTION

Engine.....	10
[10.001] Engine and crankcase	10.1
[10.216] Fuel tanks	10.2
[10.250] Turbocharger and lines.....	10.3
[10.254] Intake and exhaust manifolds and muffler	10.4
[10.400] Engine cooling system	10.5
[10.414] Fan and drive	10.6
[10.310] Aftercooler.....	10.7
[10.304] Engine lubrication system.....	10.8
Rear axle system.....	27
[27.120] Planetary and final drives	27.1
Hydrostatic drive.....	29
[29.218] Pump and motor components.....	29.1
Brakes and controls	33
[33.110] Parking brake or parking lock	33.1
[33.202] Hydraulic service brakes	33.2
Hydraulic systems.....	35
[35.000] Hydraulic systems.....	35.1
[35.300] Reservoir, cooler, and filters.....	35.2
[35.104] Fixed displacement pump.....	35.3
[35.106] Variable displacement pump	35.4
[35.105] Charge pump.....	35.5
[35.359] Main control valve.....	35.6
[35.741] Dozer blade cylinders	35.7
[35.752] Hydraulic fan drive cooling system.....	35.8

Frames and ballasting	39
[39.100] Frame	39.1
Tracks and track suspension	48
[48.134] Track tension units	48.1
[48.138] Track rollers	48.2
[48.140] Dropbox and final drive	48.3
Cab climate control	50
[50.100] Heating	50.1
[50.104] Ventilation	50.2
Electrical systems	55
[55.000] Electrical system	55.1
[55.011] Fuel tank system	55.2
[55.014] Engine intake and exhaust system.....	55.3
[55.015] Engine control system.....	55.4
[55.030] Service brake electrical system	55.5
[55.050] Heating, Ventilation, and Air-Conditioning (HVAC) control system.....	55.6
[55.100] Harnesses and connectors	55.7
[55.201] Engine starting system.....	55.8
[55.202] Cold start aid	55.9
[55.301] Alternator.....	55.10
[55.302] Battery.....	55.11
[55.512] Cab controls.....	55.12
[55.518] Wiper and washer system.....	55.13
[55.DTC] FAULT CODES.....	55.14
Dozer blade and arm.....	86
[86.110] Dozer blade	86.1
[86.124] Dozer pushbeams and struts	86.2
Tools	89

[89.128] Ripper assembly	89.1
Platform, cab, bodywork, and decals	90
[90.150] Cab	90.1
[90.114] Operator protections	90.2
[90.100] Engine hood and panels	90.3

<https://caseihservicemanual.com>

<https://caseihservicemanual.com>



INTRODUCTION

<https://caseihservicemanual.com>

Contents

INTRODUCTION

Foreword - Important notice regarding equipment servicing	3
Foreword - How to use and navigate through this manual (*)	4
Safety rules (*)	9
Safety rules (Signal word definitions) (*)	10
Safety rules (*)	11
Safety rules (Weld works) (*)	13
Safety rules - (Machine service) (*)	15
Torque (*)	23
Torque - Standard torque data for hydraulics (*)	27
Torque - Special torques	29
Basic instructions - Shop and assembly	31
Basic instructions (Daily inspection) (*)	33
General specifications (*)	35
Tracks (*)	37
Machine specifications and dimensions (*)	38
Ripper specifications (*)	40
Machine weights (*)	41
Conversion factors (*)	42
Consumables (*)	55
Consumables - Loctite® product chart	57
Hydraulic contamination	63
Product identification (Sides of the machine) (*)	64
Part identification - (Identification plates) (*)	65
Part identification (Access doors and filling locations) (*)	67
Product overview - (Machine Components) (*)	71

(*) See content for specific models

Foreword - Important notice regarding equipment servicing

All repair and maintenance work listed in this manual must be carried out only by qualified dealership personnel, strictly complying with the instructions given, and using, whenever possible, the special tools.

Anyone who performs repair and maintenance operations without complying with the procedures provided herein shall be responsible for any subsequent damages.

The manufacturer and all the organizations of its distribution chain, including - without limitation - national, regional, or local dealers, reject any responsibility for damages caused by parts and/or components not approved by the manufacturer, including those used for the servicing or repair of the product manufactured or marketed by the manufacturer. In any case, no warranty is given or attributed on the product manufactured or marketed by the manufacturer in case of damages caused by parts and/or components not approved by the manufacturer.

The manufacturer reserves the right to make improvements in design and changes in specifications at any time without notice and without incurring any obligation to install them on units previously sold. Specifications, descriptions, and illustrative material herein are as accurate as known at time of publication but are subject to change without notice.

In case of questions, refer to your CASE CONSTRUCTION Sales and Service Networks.

<https://caseihservicemanual.com>

Foreword - How to use and navigate through this manual

2050M XLT, With cab, Tier 2, Bulldozer (BD) Blade, Made in Brazil	LA
2050M XLT, With cab, Tier 2, Power Angle Tilt (PAT) Blade, Made in Brazil	LA
2050M XLT, With cab, Tier 3, Bulldozer (BD) Blade, Made in Brazil	
2050M XLT, With cab, Tier 3, Power Angle Tilt (PAT) Blade, Made in Brazil	

This manual has been produced by a new technical information system. This new system is designed to deliver technical information electronically through web delivery (eTIM), DVD, and paper manuals. A coding system called SAP has been developed to link the technical information to other Product Support functions, e.g., Warranty.

Technical information is written to support the maintenance and service of the functions or systems on a customer's machine. When a customer has a concern on their machine it is usually because a function or system on their machine is not working at all, is not working efficiently, or is not responding correctly to their commands. When you refer to the technical information in this manual to resolve that customer's concern, you will find all the information classified using the SAP coding, according to the functions or systems on that machine. Once you have located the technical information for that function or system, you will then find all the mechanical, electrical or hydraulic devices, components, assemblies, and sub assemblies for that function or system. You will also find all the types of information that have been written for that function or system: the technical data (specifications), the functional data (how it works), the diagnostic data (fault codes and troubleshooting), and the service data (remove, install adjust, etc.).

By integrating SAP coding into technical information, you will be able to search and retrieve just the right piece of technical information you need to resolve that customer's concern on his machine. This is made possible by attaching 3 categories to each piece of technical information during the authoring process.

The first category is the Location, the second category is the Information Type and the third category is the Product:

- LOCATION - the component or function on the machine, that the piece of technical information is going to describe (e.g., Fuel tank).
- INFORMATION TYPE - the piece of technical information that has been written for a particular component or function on the machine (e.g., Capacity would be a type of Technical Data describing the amount of fuel held by the fuel tank).
- PRODUCT - the model for which the piece of technical information is written.

Every piece of technical information will have those three categories attached to it. You will be able to use any combination of those categories to find the right piece of technical information you need to resolve that customer's concern on their machine.

That information could be:

- the procedure for how to remove the cylinder head
- a table of specifications for a hydraulic pump
- a fault code
- a troubleshooting table
- a special tool

Manual content

This manual is divided into Sections. Each Section is then divided into Chapters. Contents pages are included at the beginning of the manual, then inside every Section and inside every Chapter. An alphabetical Index is included at the end of each Chapter. Page number references are included for every piece of technical information listed in the Chapter Contents or Chapter Index.

Each Chapter is divided into four Information types:

- Technical Data (specifications) for all the mechanical, electrical or hydraulic devices, components, assemblies or sub-assemblies.
- Functional Data (how it works) for all the mechanical, electrical or hydraulic devices, components, assemblies or sub-assemblies.
- Diagnostic Data (fault codes, electrical and hydraulic troubleshooting) for all the mechanical, electrical or hydraulic devices, components, assemblies or sub-assemblies.
- Service Data (remove disassemble, assemble, install) for all the mechanical, electrical or hydraulic devices, components, assemblies or sub-assemblies.

Sections

Sections are grouped according to the main functions or a systems on the machine. Each Section is identified by a number (00, 35, 55, etc.). The Sections included in the manual will depend on the type and function of the machine that the manual is written for. Each Section has a Contents page listed in alphabetic/numeric order. This table illustrates which Sections could be included in a manual for a particular product.

SECTION	PRODUCT					
	Tractors					
	Vehicles with working arms: backhoes, excavators, skid steers,					
	Combines, forage harvesters, balers,					
	Seeding, planting, floating, spraying equipment,					
Mounted equipment and tools,						
00 - Maintenance	X	X	X	X	X	
05 - Machine completion and equipment	X	X	X	X	X	
10 - Engine	X	X	X	X		
14 - Main gearbox and drive	X	X	X	X		
18 - Clutch	X	X	X			
21 - Transmission	X	X	X	X		
23 - Four wheel drive (4WD) system	X	X	X	X		
25 - Front axle system	X	X	X	X		
27 - Rear axle system	X	X	X	X		
29 - Hydrostatic drive	X	X	X	X		
31 - Power Take-Off (PTO)	X		X			
33 - Brakes and controls	X	X	X	X		
35 - Hydraulic systems	X	X	X	X		
36 - Pneumatic system	X	X	X	X		
37 - Hitches, drawbars and implement couplings	X		X	X		
39 - Frames and ballasting	X	X	X	X	X	
41 - Steering	X	X	X	X		
44 - Wheels	X	X	X	X		
46 - Steering clutches						
48 - Tracks and track suspension	X	X	X			
50 - Cab climate control	X	X	X	X		
55 - Electrical systems	X	X	X	X	X	
56 - Grape harvester shaking						
58 - Attachments/headers			X			
60 - Product feeding			X			

INTRODUCTION

61 - Metering system				X	
62 - Pressing - Bale formation			X		
63 - Chemical applicators				X	
64 - Chopping			X		
66 - Threshing			X		
68 - Tying/Wrapping/Twisting			X		
69 - Bale wagons					
70 - Ejection			X		
71 - Lubrication system	X	X	X	X	X
72 - Separation			X		
73 - Residue handling			X		
74 - Cleaning			X		
75 - Soil preparation/Finishing					
76 - Secondary cleaning / Destemmer					
77 - Seeding				X	
78 - Spraying				X	
79 - Planting				X	
80 - Crop storage / Unloading			X		
82 - Front loader and bucket	X	X			
83 - Telescopic single arm	X	X			
84 - Booms, dippers and buckets	X	X			
86 - Dozer blade and arm	X	X			
88 - Accessories	X	X	X	X	X
89 - Tools	X	X	X	X	X
90 - Platform, cab, bodywork and decals	X	X	X	X	X

<https://caseihservicemanual.com>

Chapters

Each Chapter is identified by a number e.g. Engine - Engine and crankcase - 10.001. The first number is identical to the Section number i.e. Chapter 10.001 is inside Section 10, Engine. The second number is representative of the Chapter contained within the Section.

CONTENTS

The Chapter Contents lists all the technical data (specifications), functional data (how it works), diagnostic data (fault codes and troubleshooting), and service data (remove, install, adjust, etc.), that have been written in that Chapter for that function or system on the machine.

Contents

	ENGINE	
	ENGINE - Engine and crankcase – 10.001	
TECHNICAL DATA		
ENGINE - Engine and crankcase - General specification (10.001 - D.40.A.10)		4
FUNCTIONAL DATA		
ENGINE - Engine and crankcase - Dynamic description (10.001 - C.30.A.10)		6
SERVICE		
ENGINE - Engine and crankcase - Remove (10.001 -F.10.A.10)		8
DIAGNOSTIC		
ENGINE - Engine and crankcase - Troubleshooting (10.001 - G.40.A.10)		10

INDEX

The Chapter Index lists in alphabetical order all the types of information (called information units) that have been written in that Chapter for that function or system on the machine.

Index

	ENGINE - 10	
	ENGINE	
ENGINE - Engine and crankcase - Dynamic description (10.001 - C.30.A.10)		6
ENGINE - Engine and crankcase - General specification (10.001 - D.40.A.10)		4
ENGINE - Engine and crankcase - Remove (10.001 -F.10.A.10)		8
ENGINE - Engine and crankcase - Troubleshooting (10.001 - G.40.A.10)		10

Information units and information search

Each chapter is composed of information units. Each information unit has the SAP code shown in parentheses. This indicates the function and type of information in that information unit. Each information unit has a page reference within that Chapter. The information units provide a quick and easy way to find just the right piece of technical information you are looking for.

Example information unit	Engine block cover - Front – Remove (10.102.AP.01 - F.10.A.10)					
Information Unit SAP code	10	102	AK	01	F	10.A.10
SAP code classification	Engine	Pan and covers	Engine block cover	Front cover	Service data	Remove

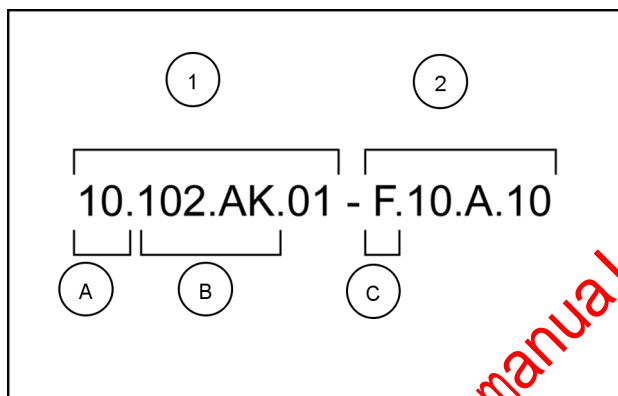

NHIL12GEN0070A 1

Navigate to the correct information unit you are searching for by identifying the function and information type from the SAP code.

- **(1)** Location and **(2)** Information type.
 - **(A)** corresponds to the sections of the service manual.
 - **(B)** corresponds to the chapters of the service manual. After **(B)** there may be some additional information. In this case it shows “.01”, which represents the “Front” block cover. These options may be front/rear, left/right, hydraulic/mechanical etc.
 - **(C)** corresponds to the type of information listed in the chapter contents: Technical Data, Functional Data, Diagnostic, or Service.
 - **(A)** and **(B)** are also shown in the page numbering on the page footer.
- THE REST OF THE CODING IS NOT LISTED IN ALPHANUMERIC ORDER IN THIS MANUAL.
- You will find a table of contents at the beginning and end of each section and chapter. You will find an alphabetical index at the end of each chapter.
 - By referring to **(A)**, **(B)** and **(C)** of the coding, you can follow the contents or index (page numbers) and quickly find the information you are looking for.

Page header and footer

The page header will contain the following references:

- Section and Chapter description

The page footer will contain the following references:

- Publication number for that Manual.
- Version reference for that publication.
- Publication date
- Section, chapter, and page reference e.g. 10.102 / 9

Safety rules

2050M XLT, With cab, Tier 2, Bulldozer (BD) Blade, Made in Brazil	LA
2050M XLT, With cab, Tier 2, Power Angle Tilt (PAT) Blade, Made in Brazil	LA
2050M XLT, With cab, Tier 3, Bulldozer (BD) Blade, Made in Brazil	
2050M XLT, With cab, Tier 3, Power Angle Tilt (PAT) Blade, Made in Brazil	

Ecology and environment

Soil, air and water are vital factors of life in general. Disposing of waste improperly represents a danger for the environment.

NOTE: Some recommendations must be followed:

- Obtain information about the correct methods to recycle or dispose of waste from local authorities, collection centers or your dealer.
- Do not dispose of waste onto the ground, into drains, or in water beds.
- Do not fill reservoirs using cans or inappropriate pressurized fluid delivery systems, as they may cause considerable spillage.
- Use sealed containers when draining the fluids. Do not use containers for food or beverages which may induce ingestion.
- The air conditioning system is under pressure, and contains gases that should not be released into the atmosphere. Do not disconnect or remove any component from the pressure line of the air conditioning system. If you need repairs to the air conditioning system, contact a dealer.
- Immediately repair any leaks or defects in the machine's engine cooling and hydraulic systems.
- Generally avoid skin contact with any fuels, oils, fluids, acids, solvents, etc. Most of them contain substances which may be harmful to your health.
- Avoid spills when draining fluid. Store them safely until they can be disposed of properly in compliance with local legislation.
- Protect hoses and pipes during welding works, because the sparks generated during the welding work can damage them, allowing the fluid to leak.

Mandatory recycling

The battery is essentially composed of lead plates and sulfuric acid solution. Because the battery contains heavy metals such as lead, resolution 401*de 2008 of CONAMA orders that all used batteries must be returned to the battery dealer at the time of replacement. Do not dispose of the battery in the garbage. Points of sale are obliged to accept the return of your used battery, and to store it in a suitable place and return it to the manufacturer for recycling.

Improper disposal of batteries can contaminate the soil, groundwater and waterways. Consumption of contaminated water can cause serious health risks. Contact of the acid solution with the skin or eyes can cause serious injury and blindness. In case of accidental contact with the eyes or skin, immediately wash with running water and seek emergency medical care.



CUIL13TRO0091AA 1

Safety rules (Signal word definitions)

2050M XLT, With cab, Tier 2, Bulldozer (BD) Blade, Made in Brazil	LA
2050M XLT, With cab, Tier 2, Power Angle Tilt (PAT) Blade, Made in Brazil	LA
2050M XLT, With cab, Tier 3, Bulldozer (BD) Blade, Made in Brazil	
2050M XLT, With cab, Tier 3, Power Angle Tilt (PAT) Blade, Made in Brazil	

Personal Safety



This is the safety alert symbol. It is used to alert you to potential personal injury hazards. Obey all safety messages that follow this symbol to avoid possible death or injury.

Throughout this manual and on machine safety signs, you will find the signal words DANGER, WARNING, and CAUTION followed by special instructions. These precautions are intended for your personal safety and for all those involved in the work activity during operation of the machine.

Read and understand all the safety messages in this manual before you operate or service the machine.

DANGER:

 Indicates an immediate danger that, if not avoided, will cause death or serious injury. The color associated with Danger is RED.

WARNING:

 Indicates a potential danger that, if not avoided, will cause serious injury. The color associated with Warning is ORANGE.

CAUTION:

 Indicates a potential danger that, if not avoided, can cause minor or moderate injury. ORANGE also alerts the operator to unsafe practices. The color associated with Caution is YELLOW.

FAILURE TO FOLLOW DANGER, WARNING AND CAUTION MESSAGES COULD RESULT IN DEATH OR SERIOUS INJURY.

Machine safety

NOTICE: Indicates a situation that, if not avoided, could result in machine or property damage. The color associated with Notice is BLUE.

Throughout this manual you will find the signal word Notice followed by special instructions to prevent machine or property damage. The word Notice is used to address practices not related to personal safety.

Information

NOTE: Indicates additional information which clarifies steps, procedures, or other information in this manual.

Throughout this manual you will find the word NOTE followed by additional information about a step, procedure or other information in the manual. The word NOTE is not intended to address personal safety or property damage.

Safety rules

2050M XLT, With cab, Tier 2, Bulldozer (BD) Blade, Made in Brazil	LA
2050M XLT, With cab, Tier 2, Power Angle Tilt (PAT) Blade, Made in Brazil	LA
2050M XLT, With cab, Tier 3, Bulldozer (BD) Blade, Made in Brazil	
2050M XLT, With cab, Tier 3, Power Angle Tilt (PAT) Blade, Made in Brazil	

Standard safety precautions

Be informed and notify personnel of the laws in force regulating safety, and provide documentation available for consultation.

- Keep working areas as clean as possible.
- Ensure that working areas are provided with emergency boxes. They must be clearly visible and always contain adequate sanitary equipment.
- Fire extinguishers must be properly identified and always be clear of obstructions. Their efficiency must be checked on a regular basis and personnel must be trained on proper interventions and priorities.
- Keep all emergency exits free of obstructions and clearly marked.
- Smoking in working areas subject to fire danger must be strictly prohibited.

Prevention of injury

- Wear suitable work attire and safety glasses with no jewelry such as rings and chains when working close to engines and equipment in motion.
- Wear safety gloves and goggles when performing the following operations:
 - Topping off or changing lubrication oils.
 - Using compressed air or liquids at a pressure greater than **2 bar (29 psi)**.
- Wear a safety helmet when working close to hanging loads or equipment working at head level.
- Always wear safety shoes and fitting clothes.
- Use protection cream for hands.
- Change wet clothes as soon as possible.
- In the presence of voltages exceeding **48-50 V**, verify the efficiency of the ground and mass electrical connections. Ensure that hands and feet are dry and use isolating foot boards. Workers should be properly trained to work with electricity.
- Do not smoke or start an open flame close to batteries and any fuel material.
- Place soiled rags with oil, diesel fuel or solvents in specially provided anti-fire containers.
- Do not use any tool or equipment for any use other than what it was originally intended for. Serious injury may occur.
- If running an engine indoors, make sure there is a sufficient exhaust fan in use to eliminate exhaust fumes.

During maintenance

- Never open the filler cap of the cooling system when the engine is hot. High temperature liquid at operating pressure could result in serious danger and risk of burn. Wait until the temperature decreases under **50 °C (122 °F)**.
- Never add coolant to an overheated engine and use only appropriate liquids.
- Always work when the engine is turned off. Certain circumstances require maintenance on a running engine. Be aware of all the risks involved with such an operation.
- Always use adequate and safe containers for engine fluids and used oil.
- Keep engine clean of any spilled fluids such as oil, diesel fuel, and or chemical solvents.
- Use of solvents or detergents during maintenance may emit toxic vapors. Always keep working areas aerated. Wear a safety mask if necessary.
- Do not leave soiled rags that may contain any flammable substances close to the engine.

- Always use caution when starting an engine after any work has been performed. Be prepared to cut off intake air in case of engine runaway.
- Never disconnect the batteries while the engine is running.
- Disconnect the batteries prior to performing any work on the equipment.
- Disconnect the batteries to place a load on them with a load tester.
- After any work is performed, verify that the battery clamp polarity is correct and that the clamps are tight and safe from accidental short circuit and oxidation.
- Before disconnecting any pipelines (pneumatic, hydraulic, fuel pipes, etc.), verify that all pressure has been released. Take all necessary precautions bleeding and draining residual pressure. Always wear the proper safety equipment.
- Do not alter the lengths of any wires.
- Do not connect any electronic service tool to the engine electrical equipment unless specifically approved by CASE CONSTRUCTION.
- Do not modify the fuel system or hydraulic system unless approved by CASE CONSTRUCTION. Any unauthorized modification will compromise warranty assistance and may affect engine operation and life span.

For engine equipped with an electronic control unit

- Do not weld on any part of the equipment without removing the control unit.
- Remove the in case of work requiring heating over **80 °C (176 °F)**.
- Do not paint the components and the electronic connections.
- Do not alter any data filed in the electronic control unit driving the engine. Any manipulation or alteration of electronic components will void engine warranty assistance and may affect the correct working order and life span of the engine.

Respect of the Environment

- Respect of the environment should be of primary importance. Take all necessary precautions to ensure personnel's safety and health.
- Inform the personnel of the laws regarding the dispensing of used engine fluids.
- Handle batteries with care, storing them in a well ventilated environment and within anti-acid container.

<https://caseih.servicemanual.com>

Safety rules (Weld works)

2050M XLT, With cab, Tier 2, Bulldozer (BD) Blade, Made in Brazil	LA
2050M XLT, With cab, Tier 2, Power Angle Tilt (PAT) Blade, Made in Brazil	LA
2050M XLT, With cab, Tier 3, Bulldozer (BD) Blade, Made in Brazil	
2050M XLT, With cab, Tier 3, Power Angle Tilt (PAT) Blade, Made in Brazil	

▲ WARNING

Avoid injury!

When welding, always wear proper protective equipment and welding clothing. All persons in the work area must, at minimum, wear welding goggles. Never look directly at the welding arc without welding eye protection.

Failure to comply could result in death or serious injury.

W1178A

NOTICE: Repair works with welding must be performed by a qualified and experienced welder. Appropriate safety regulations should be followed by the personnel involved in the work. The time to perform welding operations depends on the quality and precision of the work. Never make modifications on the machine.

To perform welding operations on the machine (authorized and in accordance with CASE CONSTRUCTION recommendations), proceed as follows:

- Identify all points of fracture or cracking, and the areas in which welding is required.
- Thoroughly clean the areas involved.
- Remove all paint. Inspect the parts with liquid penetrant or a magnetic tool for particles.
- Shut down the engine. Place the ignition key in the "OFF" position to shut down the engine.

NOTICE: After you shut down the machine, wait at least **8 min** to shut down the battery cables or the master switch (if equipped). This time is necessary so that the engine's electronic system (if equipped) can store the settings data in the electronic module.

- Disconnect the batteries and the wires from terminals D+ and B+ of the alternator.
- Disconnect the electrical wiring harnesses from the transmission control modules and from the engine.
- Connect the ground cable of the welding machine to the component to be welded.
- Always connect the welding equipment to the frame that is being welded.
- Never connect the welding equipment ground to a component of the hydraulic system.
- Avoid welding at low temperatures, e.g., below **16 °C**. If necessary, warm up the part involved prior to welding.
- Remove the paint from all surfaces before heating or welding. Painted surfaces can generate toxic gases when heated or welded.
- Use appropriate masks or protective goggles.
- Wear appropriate gloves and protective equipment.
- Disconnect the connectors from all control modules of the machine.



SP0064 1

Heating lines containing pressurized fluid

NOTICE: Flammable sprays can be generated by heating near lines containing pressurized fluid, resulting in severe burns to those doing the repair and to bystanders.

- Do not cause heating by welding, or use open flames near the components containing pressurized fluid or other flammable materials.
- Install temporary fire protection to protect the lines and other components of the machine when you perform a welding procedure.

NOTE: Pressurized lines can be accidentally cut when the heat goes beyond the area of the flame.

- Avoid heating lines containing flammable fluids
- Do not weld or torch cut lines that contain flammable fluids.
- Clean the lines to be welded or cut with non-flammable solvents before welding or cutting them.

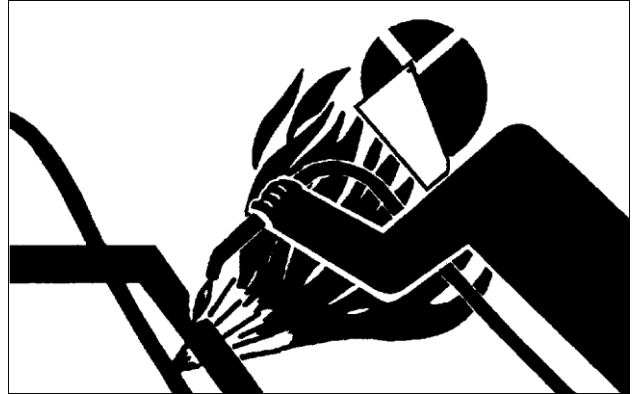

SP0059 2

Remove the paint before welding or heating

NOTICE: Hazardous fumes can be generated when the paint is heated by the welding arc or torch flame. If inhaled, these fumes may be harmful to your health.

- Do not breath in potentially toxic fumes and dust.
- Do all such work outside or in a well-ventilated area.
- Handle and dispose of waste from paints or solvents in accordance with environmental regulations, laws, and government codes.
- Remove the paint from the part to be welded before welding or heating operations.
- When sanding or grinding the paint, avoid breathing in the dust.
- Wear an approved respirator.
- If you use solvent or paint stripper, remove the stripper with soap and water before welding operations.
- Remove solvent or paint stripper containers and other flammable material from area.
- Allow the fumes to disperse for at least **15 min** before welding or heating operations.



SP0060 3

Safety rules - (Machine service)

2050M XLT, With cab, Tier 2, Bulldozer (BD) Blade, Made in Brazil	LA
2050M XLT, With cab, Tier 2, Power Angle Tilt (PAT) Blade, Made in Brazil	LA
2050M XLT, With cab, Tier 3, Bulldozer (BD) Blade, Made in Brazil	
2050M XLT, With cab, Tier 3, Power Angle Tilt (PAT) Blade, Made in Brazil	

NOTICE: Carefully read the Operation and Maintenance Manual before you turn on, operate, perform maintenance, fuel, or repair the machine in any way.

Safe maintenance

- Unexpected machine movement can cause serious injury.
- Place a “Do Not Operate” tag on the ignition key before you start any maintenance procedure on the machine.
- Observe, understand, and follow the instructions on all safety decals on the machine. If you have any questions, see the “Safety Decals” section in this manual.
- Keeps all safety signs and decals clean and legible.

NOTE: Replace decals that are unreadable, damaged, or missing, as required.

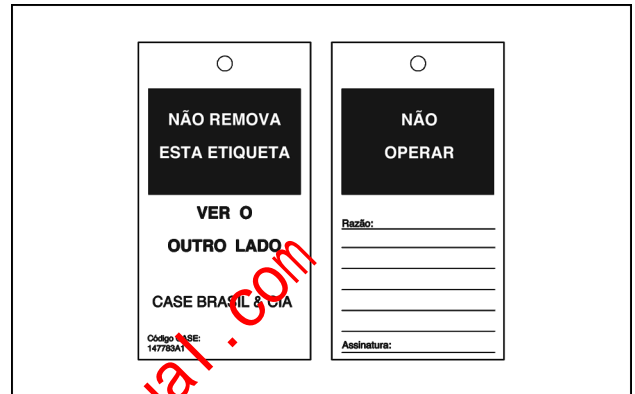

147783A1_B 1

- Never allow unauthorized persons without training or knowledge of the machine to perform maintenance tasks.
- Follow all of the recommended maintenance and service procedures.
- Do not leave the operator's seat if the operation requires that the engine remains on. If necessary, call another person to assist you in the verification procedure with the machine in operation.
- Keep all machine components in good condition and installed correctly.
- Immediately repair any fault.
- Replace worn or failed components.
- Remove grease, oil, and accumulated debris.



SP0039 2

Moving parts

- Keep hands and clothing away from moving parts.
- Do not wear rings, wrist watches, jewellery, loose or hanging garments, such as ties, torn clothing, scarves, unbuttoned or unzipped jackets that can get caught by movements of rotating components.

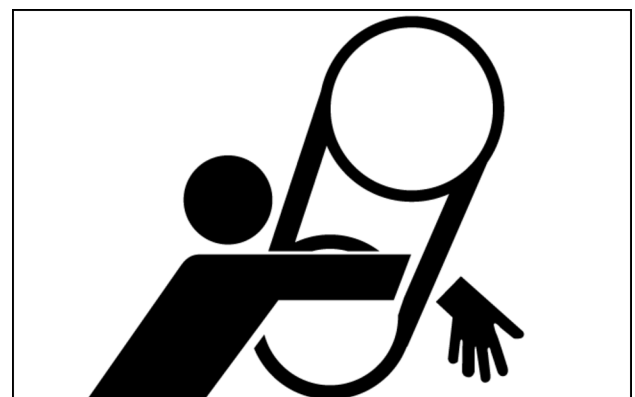

SP0041 3

Maintenance with the engine in operation

- Do not perform any maintenance operation with the engine running.
- Contact with moving parts can cause serious injuries.
- Stop the engine and wait for it to cool off prior to performing maintenance operations.

NOTE: If the engine must be on to make certain adjustments, first place the transmission into neutral. Apply the parking brake. Place the implement in a safe position. Securely block the wheels. Use extreme caution.

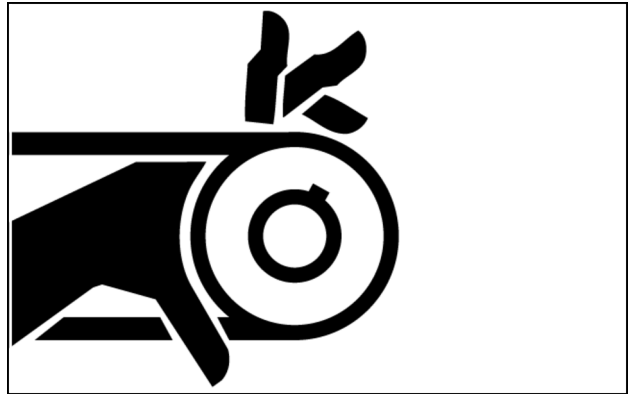

SP0042 4

Protective equipment

- Familiarize yourself with the safety and protection regulations.
- Always wear certified safety equipment such as: hard hat, no-slip footwear, protective gloves (to handle chains and cables), ear protection, protective goggles, reflector vests, and respirators when required.

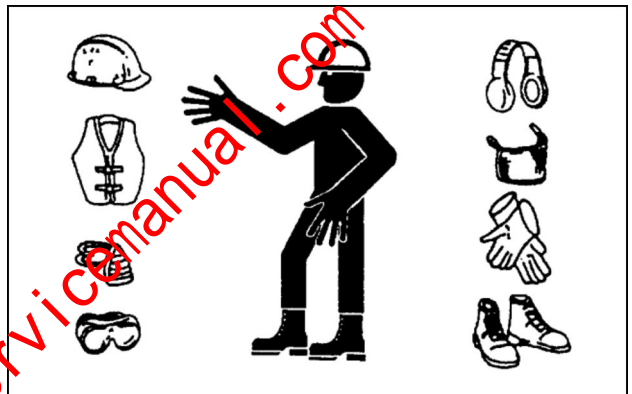

SP0005 5

Support cradles

- Do not use the control levers or hydraulic hoses as supports.
- The hydraulic hoses and the control levers are movable parts. The hydraulic hoses and the control levers do not provide solid support. Also, the control levers can be moved inadvertently and cause unexpected movement of the machine or its attachments.
- Do not jump on or off the machine. Always maintain at least three points of support between the steps and the handrails.
- Always keep the operator's compartment, steps, handrails and control handles clean and clear of foreign objects, oil, grease, mud or snow to reduce the risk of slipping or stumbling.
- Remove mud or grease from your shoes before entering the cab to operate the machine.

Support, block, and protect the machine properly

- Do not perform maintenance work on a machine that is not properly supported.
- Always support the implement on the ground before starting the maintenance work.
- If it is necessary to perform maintenance on a machine with the implement raised, make sure to support it firmly.
- Do not support the machine on bricks, boards or other material that could collapse under load.
- Do not perform maintenance work on a machine that is supported solely by a jack.
- Lock the machine components that must be raised for maintenance using appropriate lifting equipment.
- Always lock all moving components or parts of the machine that should be lifted for maintenance purposes using adequate external lifting equipment as required by local regulations.
- Do not allow anyone to pass or remain near or below a raised attachment.

NOTE: Never move or stop the bucket above people or a cab of another machine or truck.

- When the maintenance to be performed requires access to areas that cannot be reached from the ground, use a ladder or scaffolding.
- Workshop maintenance or field scaffolding should be manufactured and maintained in accordance with the safety regulations.

NOTE: If a ladder or scaffolding are not available, use the machine handrails and steps.

- Perform any maintenance work with the greatest care and attention.
- Do not place your head, body, limbs, hands, feet, or fingers near the articulated cutting edges without the necessary protection.
- Securely block the machine or any component that may fall before working on the machine or component. If possible, also use an auxiliary or backup blocking device.

NOTE: To prevent unexpected movement, securely block the working elements whenever you service or replace working tool parts such as cutting edges.



SP0040 6